

# Starry Sky at BioDiff

# Contents

## Instrumentation

HEiDI and POLI .....	4
Out of the Box .....	5
KOMPASS .....	6
BioDiff .....	8
Magnet at JCNS.....	9
MIEZE at MIRA and RESEDA.....	10
PGAA .....	11
Faster, Higher, Further.....	12

## Science & Projects

Ferroelectrics, Batteries and Shape Memory Alloys .....	20
High Speed Texture Analysis .....	22
ERC Grant for Research on Magnetic Vortices.....	23
ESMI .....	24

## Outside

KFN .....	30
-----------	----

## Events

5 <sup>th</sup> ECNS .....	16
4 <sup>th</sup> SSRDM 2011.....	17
15 <sup>th</sup> JCNS LabCourse .....	17
Neutron Scattering for Crystallographers.....	18
JCNS Workshop on Neutron Instrumentation .....	18
Science Vision for the ESS .....	19
FRM II open day.....	19

## Inside

Staff Exchange .....	25
Newly Arrived .....	26
First Work Experience at a Neutron Source.....	28
Excellence Times Three .....	29

## User Office

User Meeting 2012.....	31
Upcoming User Survey .....	31
Reactor Cycles 2012.....	31
Proposal Deadlines 2012 .....	31
Call for proposals .....	33
Upcoming .....	34

**Don't forget to submit your proposal!**  
**Next deadline: January 27<sup>th</sup>, 2012**



[user.frm2.tum.de](http://user.frm2.tum.de)

[fzj.frm2.tum.de](http://fzj.frm2.tum.de)



news 7 (2011)



## Dear users of the FRM II,

since 2011 the scientific use of FRM II is jointly organized by the Technische Universität München (TUM) and the Helmholtz Association with significant additional funding from the German federal government. The Helmholtz Association, namely the Forschungszentrum Jülich (FZJ), the Helmholtz Zentrum Geesthacht (HZG) and the Helmholtz Zentrum Berlin (HZB) together contribute nearly half of the instruments of the FRM II.

Within this new collaboration, the HZG focuses on materials research. For this purpose HZG operates the **German Engineering Materials Science Centre (GEMS, [gems.hzg.de](http://gems.hzg.de))** as a platform providing a worldwide unique infrastructure for the complementary research with neutrons (HZG-outstation at the FRM II in Garching) and photons (HZG-outstation at DESY in Hamburg) especially in the field of engineering materials science. During 2012 a new proposal system will be installed, enabling users to fully exploit the complementarity of the two probes by applying for beamtime at GEMS instruments at FRM II and DESY within one proposal. Users will also have access to additional user support facilities for preparation and analysis of samples in the vicinity of the GEMS instruments. At the FRM II, a materials science lab will be operated in close cooperation between GEMS and TUM from 2012 onwards for this purpose.

The GEMS instruments at FRM II range from the GISANS and reflectometry machine REFSANS via the new small angle scattering machine SANS-1 to the stress and texture diffractometer STRESS-SPEC which partially are operated together with the TUM. The biggest investment currently goes towards the new SANS-1 instrument, which is constructed together with TUM and which should become one of the world's leading SANS machines.

GEMS is currently extending its portfolio at the FRM II towards neutron imaging, which complements the strong imaging activities of GEMS at DESY. Two specific examples of materials research with neutrons, including results on the new sample manipulation robot at STRESS-SPEC are included in this issue of the FRM II NEWS. The significant contribution of neutrons and photons to engineering materials research is highlighted in a very recent special issue of "Advanced Engineering Materials" (Adv. Eng. Mat. 13, 2011).



*Andreas Schreyer*  
is director at the Institute of Materials Research of the Helmholtz-Zentrum Geesthacht and is speaker of the Helmholtz programme "Research with Photons, Neutrons and Ions" coordinating the activities of six Helmholtz centres in this field.

## Bright Future for the Dynamical Duo

### HEiDi and POLI at beam tube SR9

Since 2009 the diffractometers HEiDi (single crystal) and POLI (polarized) had shared the same beam tube SR9B and the same monochromator unit at beam tube SR9 at the hot source of FRM II. Switching between polarized and unpolarized experiments had been done by switching between the two units leaving the other unavailable at the time. As a consequence, the large request for beamtime from the user communities of both instruments generates an extremely high overload factor and many rejected high quality proposals due to the limited beam time. To resolve this problem a new project was launched in 2010 with financial support from the BMBF to make HEiDi and POLI run parallel using both beam tubes A and B at beam tube SR9 in the near future (fig. 1).

POLI shall have its own beam tube by removing the plug from the formerly unused channel in the existing biological shielding, extending this with a new monochromator shielding and unit at its end, and splitting one experimental area into two.

In the framework of this project a major step was taken during the long maintenance break. Until the end of 2010 the diffractometer and the monochromator unit of HEiDi were dismantled and the biological shielding was partly removed to access the neutron windows of the beam shutter SR9 in the wall of the reactor vessel. To allow the independent use the three collimators of HEiDi (15', 30', 60') in the beam shutter drum were removed. In addition the plug inside beam tube SR9A was replaced by a neutron channel insert to define the beam cross section for future use on POLI. While these tasks took less than two weeks, several months of preparation were necessary due to the high activation level of the collimators and especially the plug (up to 1 Sv/h) caused by neutron irradiation. In order to minimize the radiation exposure for the involved employees, careful estimations of the expected radioactivity of all components to be handled, an accurate and tight schedule and exercises on a

dummy of the beam tube and shutter including the manufacturing of proper tools and containers

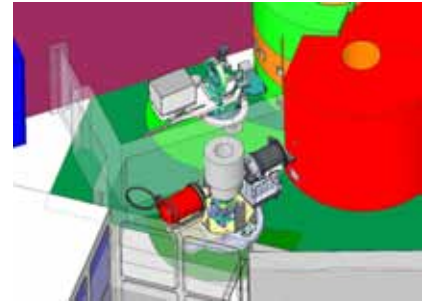

Fig. 1: HEiDi and POLI operating independently in 2013.

from lead for handling and shielding the removable parts were mandatory. We would like to thank our colleagues from the radiation protection group, the neutron optics group and beam tube SR4 for discussions and support concerning these issues. After finishing this work in March 2011, the second major goal during the break was to regain full availability and flexibility of beam tube SR9B and to introduce some improvements. The 15' and 30' collimators were conditioned and reused in a new collimator selector unit with its own controller unit. The three available positions are now 15', 30', no collimation. An improved experiment shutter system was installed. The monochromator unit of HEiDi was refurbished including an optical readjustment of the three monochromator units, connected to a new controller system for improved reliability. After successful tests of all these components the biological shielding was finally closed and the diffractometer unit HEiDi re-installed with some additional improvements like a fully automatised analyzer unit constructed for the detector unit.

Recommissioning of HEiDi and POLI at SR9B took place within the first weeks of the new reactor cycle in the end of October. The first results are very promising: The readjustment and optimisation of the beam path, monochromator and diffractometer unit yields a gain of about 25 % for the neutron flux for all monochromators (Cu-220, Cu-420, Ge-311). Additionally a background reduction of up to 30 % could also be achieved. The new collimator unit offers a neutron flux ratio of 25 % (15'), 50 % (30') and 100 % (no collimation). The profile analysis of all monochromators at  $2\Theta_{\text{Mono}} = 40^\circ$  revealed that the lamellae of the Cu-220 and Cu-420 ( $\lambda = 0.870 \text{ \AA}$  and  $\lambda = 0.550 \text{ \AA}$ ) monochromator units need some realignment while the Ge-311 unit ( $\lambda = 1.170 \text{ \AA}$ ) is within its specifications. This unit can also be used as a Ge-422 unit ( $\lambda = 0.793 \text{ \AA}$ ) and therefore as replacement for the Cu-220 unit until its full recovery in the near future (fig. 2). Other work in progress is the construction of the biological shielding for POLI which is planned to be assembled within 2012 using a new recyclable shielding material developed recently at the FRM II.

Martin Meven, FRM II

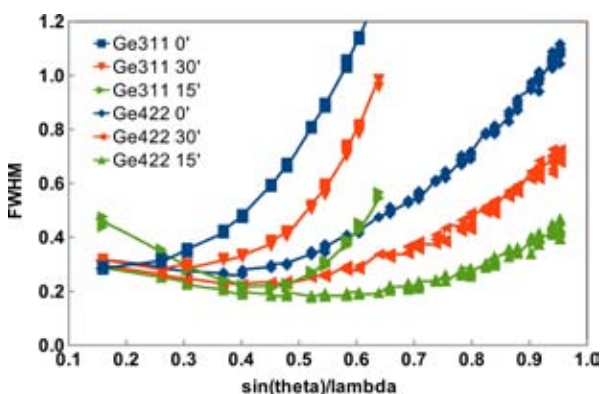

Fig. 2: Beam divergences measured at  $2\Theta=40^\circ$  with Si-single crystal on HEiDi for Ge-311 and Ge-422.





## Control boxes for sample environment applications

The FRM II, one of the most powerful neutron scattering facilities worldwide, offers a 24/7 user access to a broad variety of instruments. As a consequence, remote control of experiments is an essential tool for the effective usage of beam time. The integration of sample environment equipment operated at an experimental setup is an important part of it. Even more since setting up equipment as well as exchange-



Fig. 1: Reverse side of the control box.

ing samples fix the periods of time that are going to be the limiting factor within the experimental process. Therefore it is desirable to speed up and facilitate the integration of sample environment components.

The dry top loading cryostats (CCR) developed at FRM II for example offer in principle full remote controlled operation to users since the very beginning. The different components like start/stop of the coldhead, control of exchange gas pressure and temperature control are accessible via the TACO/TANGO control software.

A further step to facilitate the communication setup is a new universal control box recently developed by the sample environment and software groups of FRM II. This means integrating CCR-control, temperature control and optional peripheral devices like rotation tables etc. into one "black box". Basic coldhead control like start/stop of compressor or compressor error messages are handled by a programmable logic controller (PLC). Moreover, sample tube, electromagnetic valves for exchange gas and vacuum are processed by the PLC. A compact computer handles communication and operation of all different devices. Pro-

cess-oriented sequential control can be included either at the PLC or by running appropriate TACO/TANGO software. Beside the fully available local operation the box offers access via a web interface and a single Ethernet interface respectively. The TACO/TANGO software running on the included computer is designed for simple integration into the instrument control software. It offers different interfaces to the TACO/TANGO software controllers as well as a web based interface. This interface provides the display of the current state of the system like temperatures, pressure values, valve states, compressor states, etc. Additionally, there are features to control the compressor and valves. The handling of the sensor curves for the temperature controller and the settings for the temperature controller channels are also included.

An application is the CCR temperature crossover, a feature often used in soft matter experiments. The sample temperature has to be controlled from very low temperatures (some Kelvin) to comparatively high temper-

atures (e.g. 500 K). This can be done by running the cryostat at standard conditions for the low temperature regime, where the thermal coupling of the sample is accomplished by <sup>4</sup>He exchange gas in the sample tube. When going to temperatures significantly above room temperature, exchange gas has to be pumped to protect the components of the CCR and temperature sensors against thermal damage. All this can be done by appropriate TACO/TANGO sequencing software.



Fig. 2: Combination of control box (top), compressor (bottom) and CCR.

atures (e.g. 500 K). This can be done



Fig. 3: Screenshot of the web interface.

Basically, the design of the control box allows for almost all sample environment applications to offer one single communication port.

Jürgen Peters, Jens Krüger; FRM II



## KOMPASS

### KOeln Münchener auf Polarisations-Analyse Spezialisiertes Spektrometer

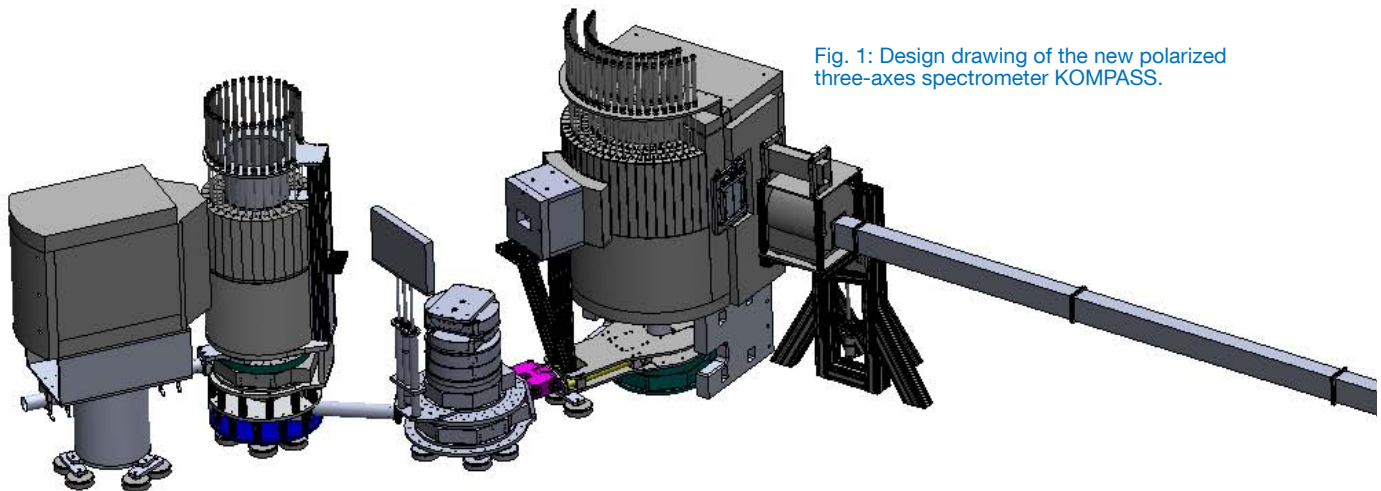

Fig. 1: Design drawing of the new polarized three-axes spectrometer KOMPASS.

KOMPASS - the new neutron three-axes spectrometer to-be at the FRM II - is a common project of the Universität zu Köln and the Technische Universität München funded by the German Federal Ministry of Education and Research (BMBF). Complementary to the other three-axes spectrometers at the FRM II - namely PANDA, PUMA, TRISP - the instrument is fully designed to work exclusively with polarized neutrons and to provide a zero-field 3D polarization analysis, often referred to as neutron polarimetry.

In the last couple of decades experiments using polarized neutrons and zero-field neutron polarimetry underwent a significant upturn while becoming more and more important for the understanding of magnetic materials. The unique possibilities provided by the spherical polarization analysis that the direction of the scattered polarization vector can be determined for any given incident polarization, and the inherent unambiguous separation of magnetic and non-magnetic signals, open up a wide field of applications. Spherical neutron polarimetry hence is a unique technique to determine complex magnetic structures and dynamics. A selection of predestinated systems for the study of their spin dynamics and structures with polarized neu-

trons and neutron polarimetry, respectively, are all types of weak magnetic orders, complex (chiral) magnetic structures (e.g. rare-earths), quantum effects associated with longitudinal magnetic excitations, quantum critical fluctuations, systems of reduced dimensions (e.g. thin films and multilayer structures), as well as multiferroic and magneto-electric materials, high- $T_c$ -superconductors and itinerant magnetic systems, to name a few.

KOMPASS will be located in the FRM II neutron guide hall west at a distance of about 45 m between the cold source and the monochromator, sharing the curved beam port NL1 with the upstream instruments NREX and BioDiff. The measuring facility for particle physics - MEPHISTO - currently located at the same end position will be relocated to the neutron guide hall east in 2012/2013.

A highlight of the KOMPASS instrument will be the state-of-the-art polarizing guide system: 6.7 m in length and parabolically focusing in the scattering plane with a successively changing coating. Together with the optimised monochromator design the parabolic guide system will provide high neutron fluxes at a small sample volume.

It will further have a superior energy resolution over an elliptic guide concept at the expense

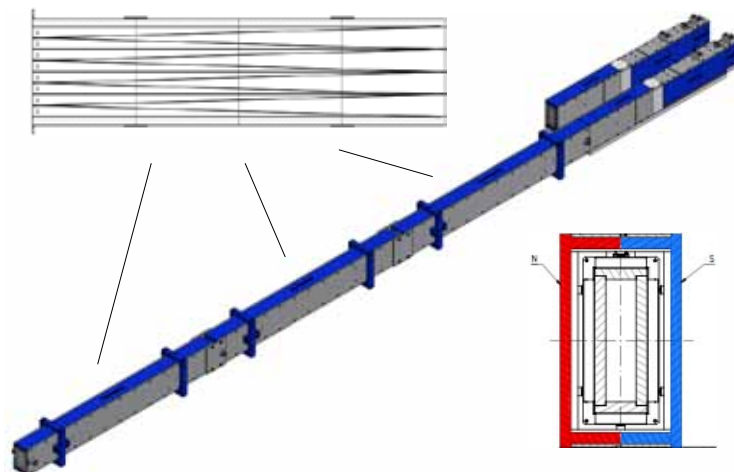

Fig. 2: Sketch of the horizontally focusing neutron guide system hosting three serial cavities. Longitudinal and transverse cuts of the guide show the stacked V-cavities (top-left) and the magnetic casing (bottom-right) providing the guide field, respectively.

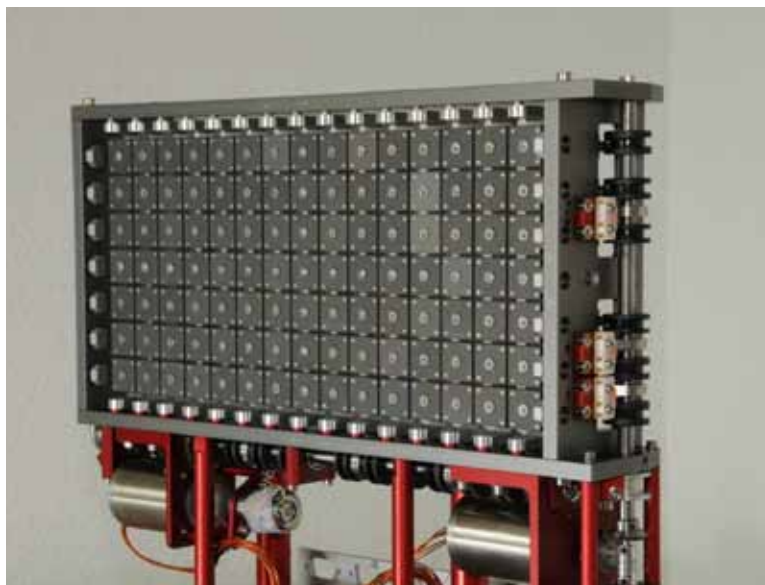

Fig. 3: Picture of a monochromator similar in construction to that to-be used on KOMPASS.

of a reduced transverse Q-resolution. Contrary, for measurements with high Q-resolution, or the investigation of a steep dispersion relation, the parabolic front ends of the guide system will be exchangeable with corresponding straight guide elements by a motorized guide changer at the expense of a relaxed energy resolution. The concept of different guide ends thereby allows to find a compromise between energy and Q-resolution that best matches the users desire. The non-magnetic coating of the neutron guide sides changes progressively with decreasing radius of the parabola, while the top and bottom parts have a constant coating.

The first part of the guide system will host three serial cavities providing a highly polarized incident neutron beam. Each of the three cavities will consist of a stack of four doubled sided Fe/Si coated silicon V-elements, shown in fig. 2.

A permanent magnetic guide field throughout the entire neutron beam path, created by permanent magnets in the casing of the guide elements and further along the beam path, will preserve the high degree of polarization.

The desired incident neutron energy at the sample position will be selected by an adjustable doubly curved array of highly oriented pyrolytic graphite (HOPG(002)) crystals. Together with the given range of take-off angles ( $28^\circ \leq 2\theta \leq 140^\circ$ ), incident neutron energies of about 2-25 meV will be thereby available. An analogous array of double focusing HOPG(002) crystals will be used to analyze the energy of the scattered neutrons. Potential higher wavelength contaminations will be suppressed in front of the monochromator by a velocity selector, which will also help to significantly reduce the background at the instrument.

Short distances between the monochromator and the sample table of about 1.2 m, and from the sample table to the analyzer and further to the detector, each of about 0.8 m, respectively, will ensure a compact instrument layout.

For sample positioning the sample table will be equipped with motorized xy-stages ( $\pm 15$  mm) and cradles ( $\pm 5$  degrees). Apart from a standard closed-cycle cryostat, the instrument will be equipped with a 3<sup>rd</sup> generation ILL system Cryopad and a mini MuPAD for neutron polarimetry.

The spin-state of the scattered neutrons will be analyzed with a single V-cavity between the analyzer and the detector. The latter will be a standard  $^3\text{He}$ -counter at the first level of development.

Currently we are finalizing the design while a number of essential components is in construction. The start-up of neutron operation at KOMPASS is foreseen in early 2013.

This project is supported by the German Federal Ministry of Education and Research (BMBF) by project 05KN7PK1 & 05K10PK1. We thank M. Janoschek and A.C. Komarek for their work.

*A.T.D. Grünwald, Universität zu Köln*



M. Braden



P. Böni



A. Grünwald



S. Giemsa

Fig. 4: The KOMPASS-Team.



## Starry Sky at BioDiff

### First tests of the BioDiff neutron image plate detector

Starting with the very first neutrons of the reactor cycle the main detector of the instrument BioDiff – a neutron image plate (NIP) detector – was tested for the first time with neutrons (fig. 1). The monochromatic single crystal diffractometer BioDiff is a joint project of the Forschungszentrum Jülich (FZJ/JCNS) and the Forschungs-Neutronenquelle Heinz Maier-Leibnitz (FRM II) and is dedicated to the data collection of crystals with large unit cells, mainly protein crystals (see FRM II NEWS No. 5).

For this purpose BioDiff provides two independent detector systems. To reduce the data col-

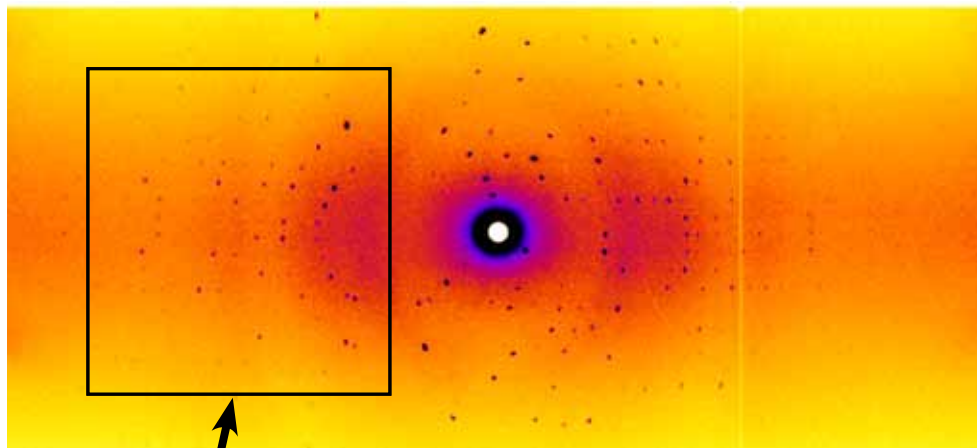

Fig. 1: Diffraction pattern of a myoglobin crystal collected with a wavelength of 2.68 Å: (top) neutron image plate detector, (left) CCD-camera system. For both cases the exposure time was 20 minutes.

lector with an active area of 200 mm x 200 mm which is imaged onto a CCD-chip. This CCD camera can rotate around the sample in a  $2\theta$  range between  $0^\circ$  and  $113^\circ$ . Having a smaller active area by comparison with the image plate detector the advantage of the CCD-camera is predominantly its fast read out time down to 1 second. Especially for strong scattering samples the CCD-camera will be the choice.

Now for the first time the detector systems could be compared directly with neutrons. The results of these tests are very promising and fully meet the expectations. The quality of both detector systems with respect to efficiency and resolution are very close together (fig. 1).

BioDiff has also a certain potential as a low resolution “substitute” powder diffractometer. Fig. 3 shows the powder pattern collected with the image plate detector of a YIG powder sample (Yttrium Iron Garnet) which was used for the wavelength calibration.

Andreas Ostermann, FRM II  
Tobias Schrader, JCNS

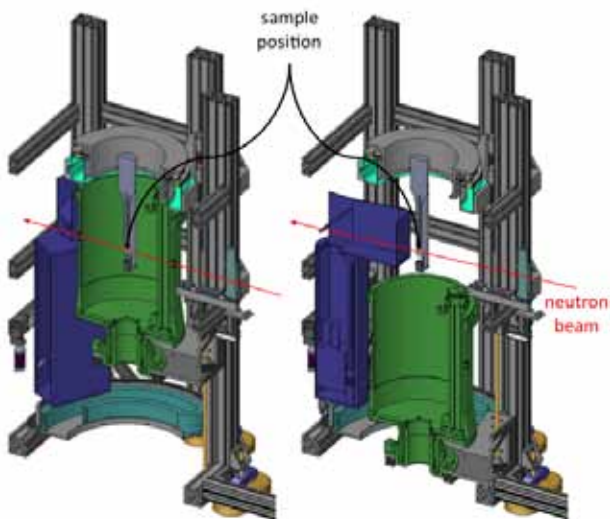

Fig. 2: Scheme of both detector systems. Neutron image plate detector in green, CCD-camera system in violet.

lection time the main detector system covers a large solid angle of approximately  $2\pi$  and consists of a cylindrical neutron image plate with a radius of 200 mm and a cylinder height of 450 mm (fig. 2). The second detector system is a Li/ ZnS scintilla-

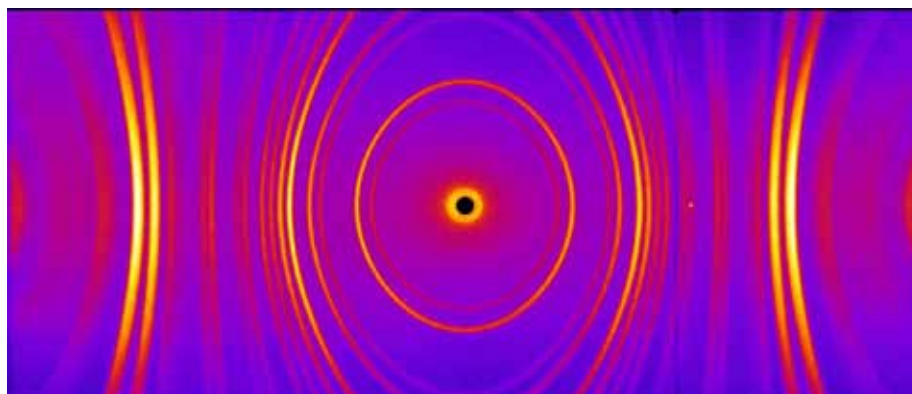

Fig. 3: Pattern of YIG (Yttrium Iron Garnet) powder sample. This sample was used for the wavelength calibration.



## Neodymium-Reduced Permanent Magnets for Wind Energy

### New JCNS cryomagnet used for the first time

Cryomagnets are used for basic research in the field of magnetism. They help investigating magnetic effects in hard matter, for example in materials of the IT- and nanotechnology.

The sample environment group of the instruments operated by the Jülich Centre for Neutron Science (JCNS) at the FRM II offers a vertical 5 Tesla cryomagnet that will be available for routine operation in spring 2012. The superconducting cryomagnet is asymmetrical and therefore also useable in the scope of polarization analysis. A very special feature is the active shielding. Thus it can be ensured that neighbouring instruments won't be influenced or hindered in their measurements.

In the end of December 2011, this magnet was used in the scope of an experiment for the first time.

The resources of neodymium are limited while the high demands for Nd appear from wind engines placed all over the world. Classical magnets in the generators still contain a high content of Nd. The idea of the research group from the University of Luxemburg aims at reducing the neodymium content in the NdFeB magnets. The reduced Nd



Fig. 1: Harald Schneider, head of the JCNS sample environment group, during the specification test.  
Table: Technical data at a glance.

<b>Maximum field</b>	$\pm 5$ Tesla
<b>Split</b>	30 mm
<b>Vertical access angle</b>	$\pm 5^\circ$
<b>Horizontal access angle</b>	330°
<b>Temperature</b>	1.6-330 Kelvin

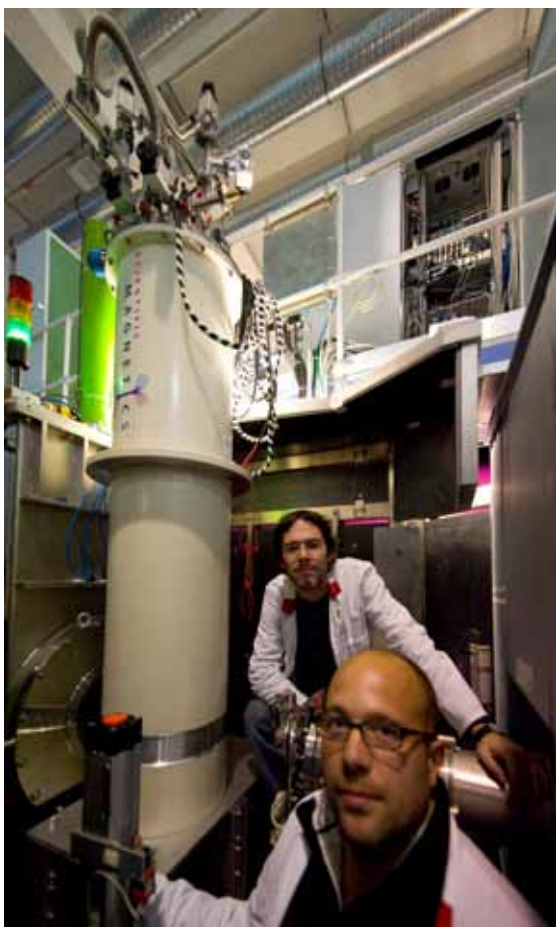

Fig. 2: The new magnet mounted on the KWS-1 and its first external users, Frank Döbrich (l.) and Jan-Peter Bick (r.) of the University of Luxemburg.

content leads to phase separation of magnetically hard Nd-rich grains coexisting with magnetically soft Nd-poor grains. The grain structure and the response of the magnetization to external magnetic fields is the topic of the current research.

The new 5 T-magnet serves a wide field range and allows for a reorientation of the magnetization. With small angle neutron scattering one observes a combination of magnetic and nuclear scattering, the separation of which is highly desired. Only then the grain structure can be separated from the magnetic structure, and correlations between different grains can be observed. While on small length scales the grain structure seems to be dominating, on large length scales the magnetic structure displays clear effects. A more detailed interpretation is currently not available.

The future extensions of KWS-1 with polarizers and polarization analysis (expected for the beginning of 2013) will highly improve the quality of experimental results from such experiments.

*Henrich Frielinghaus, JCNS*

## Manipulations in Front of Samples

### MIEZE at RESEDA and MIRA

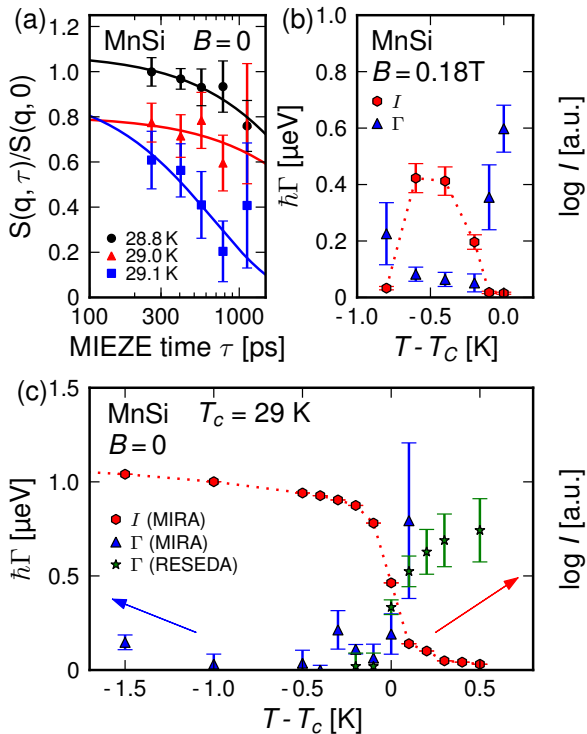
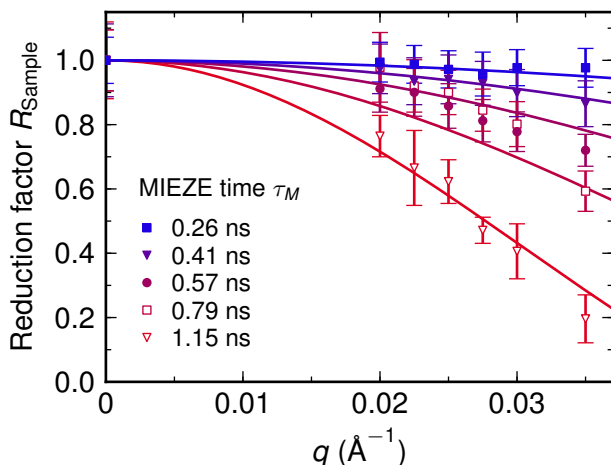

Fig. 1: (a) Typical signals in zero field for MnSi. (b) A temperature scan through the A-phase of MnSi. (c) Comparison of different NSE methods with MIEZE.

The **Neutron Spin Echo (NSE) variant MIEZE (Modulation of Intensity by Zero Effort)**, where all beam manipulations are performed before the sample position, offers the possibility to perform low background SANS measurements in strong magnetic fields and depolarising samples. Recently, we demonstrated the power of MIEZE in studies of the helimagnetic order in MnSi under applied magnetic fields (fig. 1a,b). In order to validate the MIEZE results, we proofed the equivalence of different NSE methods and MIEZE at the instruments MIRA and RESEDA (fig. 1c) at the FRM II. Good agreement between the results of these different quasielastic techniques is shown,



studying critical dynamics at the magnetic satellite peak in  $\langle 111 \rangle$  direction on MnSi (fig. 2) in zero applied field.

However, MIEZE is sensitive to differences  $\Delta L$  in the length of the neutron flight paths through the instrument and the sample. We therefore investigated the major influence of  $\Delta L$  on contrast reduction of MIEZE measurements and its minimization. In fig. 3, a comparison of the analytical calculations of the reduction factor and measurements are shown. This indicates a qualitative good understanding of the reduction effects in MIEZE.

MIEZE is now available for user operation at the instruments RESEDA and MIRA, using either a scintillation detector or the new CASCADE detectors. In quasielastic experiments using MIEZE, energy resolutions in the sub- $\mu\text{eV}$  range (up to 10 ns in time resolution respectively) were reached up to scattering vector values of  $0.1 \text{ \AA}^{-1}$ .

Robert Georgii, FRM II  
Wolfgang Häußler, FRM II

### MnSi 2D SANS

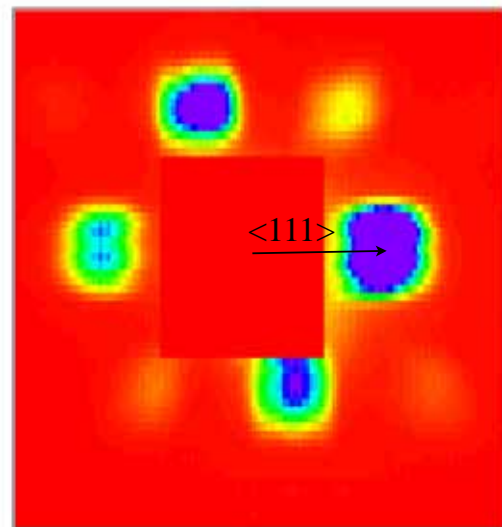

Fig. 2: Small angle neutron scattering signal in zero field from MnSi, taken with a CASCADE detector - the  $64 \times 64$  pixel are well visible. Quasielastic dynamics were measured at the magnetic satellite in  $\langle 111 \rangle$  direction.

Fig. 3: Comparison of analytical calculations of the reduction factor compared to measurements.



## The strongest beam of the world needs lowest background at PGAA

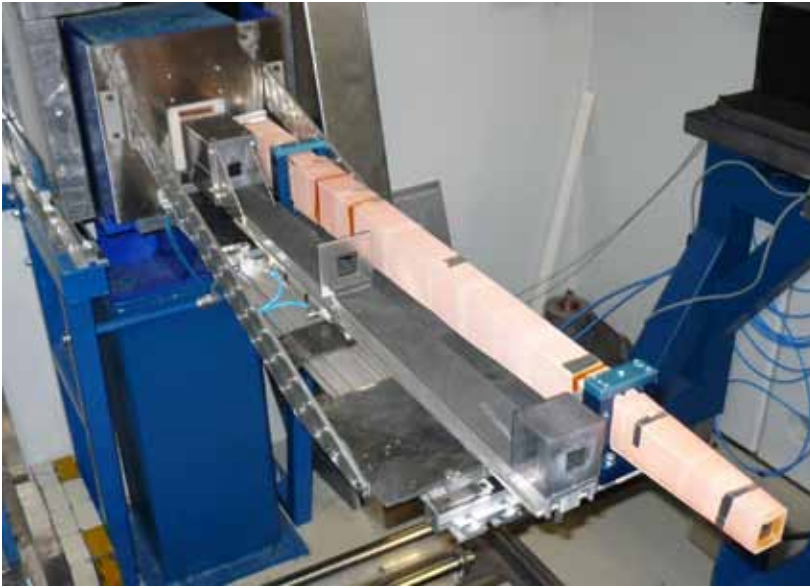

Fig. 1: A moving mechanism changes the beam collimator and the elliptical neutron guide. Here after its installation.

**Prompt Gamma Activation Analysis (PGAA)** offers a unique possibility of performing chemical analysis in neutron beam facilities. The method is non-destructive, needs no sample preparation, and the samples can be measured in any form. It is mainly used for the analysis of major components, especially light elements, and is sensitive to many nuclides of essential interest in neutron science ( $^1\text{H}$ ,  $^{10}\text{B}$ ,  $^{113}\text{Cd}$ ,  $^{149}\text{Sm}$ ,  $^{157}\text{Gd}$ , etc.) The standard way of PGAA is used for the determination of the average composition of samples with masses of 0.01–1 g, and the high-flux beams also allow many special applications.

The original PGAA device was carefully designed at the Paul Scherrer Institute (PSI), where it had been in operation from 1998 to 2001 at SINQ spallation neutron source in a beam flux of  $7 \times 10^7 \text{ cm}^{-2} \text{ s}^{-1}$ . After its shut down, the instrument was taken to the Nuclear Physics Institute of Cologne University, where it was further developed so that it could be operated flexibly in different experiments at a much stronger neutron beam. Then, jointly with FRM II, the new setup was installed and tested in the guide hall west. The PGAA facility is located at the end of the 51 m long, curved cold-neutron beam guide NL4b, whose last 7 m are elliptically shaped to increase flux. When using the focusing guide element, a thermal flux of  $6 \times 10^{10} \text{ cm}^{-2} \text{ s}^{-1}$ , the highest reported beam flux, was achieved.

Since then, the Garching PGAA facil-

ity has been opened to users, and it was mainly used for standard PGAA measurements and high-flux irradiation experiments. A few successful demonstration experiments were also performed in 2D and 3D elemental mapping, and in neutron radiography (and tomography) driven PGAA. Though the beam-to-background ratio was similarly good, as at the best facilities of the world, it became clear that this exceptionally strong beam needs even better solutions for suppressing the radiation background. That is why the instrument was reconstructed in 2011. The last removable guide section is now interchangeable with a collimator tube, making possible the use of two different beams:

the high-flux beam for special applications, and a medium-flux beam for standard PGAA. After a major reconstruction, the shielding of the different units now form closed chambers with the smallest possible openings in the direction of the beam and detection to trap scattered radiation near to its origin. As a result of this modification, the background became significantly lower, and so a dynamic range of almost three orders of magnitude is available for useful spectrum counts in standard PGAA, and more than one order of magnitude in the high-flux setup. This provides unique possibilities for the measurement of low-mass samples etc.

The detectors and the acquisition system have been under an update, too, as well as the software control of the instrument.

*Zsolt Revay, FRM II*



Fig. 2: Beam collimator and elliptical neutron guide, shielded.



# Instrumentation

## Faster, Higher, Further

### Instruments' updates during the long maintenance break

Almost every instrument out of the 24 operating ones at the neutron source Heinz Maier-Leibnitz has undergone a refurbishment during the long reactor shutdown. As a result, they are faster in changing between positions, have a higher neutron flux or obtained an improved control software.

#### NREX

The neutron reflectometer NREX has had a general overhaul. The instrument operated by the Max Planck Society has gotten new software, new detector electronics, new polarizers and a new monochromator. The operation is more stable, the handling easier. NREX now provides up to three times more flux and features a reduced background. It was available for user experiments soon after the reactor had started in October 2011.

#### SANS-1

Not yet in operation, but on the home straight is the new small angle scattering instrument SANS-1. The shielding around the collimation area and the velocity selector had been strengthened and a new one had been constructed at the sample position. The fully automated sample positioning and the safety control system had been installed. Furthermore, first neutron tests on the large area detector integrated in the 22 m detector tank had been successfully performed using a laboratory source. SANS-1 has a laser system to check the position of all optical components, which was installed and adjusted (see fig. 1).



Fig. 1: The laser system of SANS-1 is operational.

#### MIRA

A newly adjusted and mechanically improved monochromator makes MIRA more attractive.

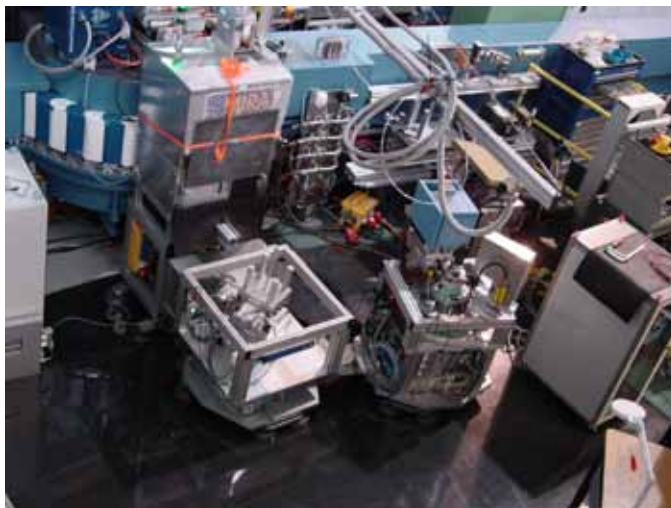

Fig. 2: MIRA can change quickly from small angle scattering mode to three-axes spectrometry and MIEZE mode.

The diffractometer had been optimized for a fast change between different operation modes, three-axes measurements, small angle scattering and MIEZE (fig. 2). Hard- and software for instrument control had been exchanged, the sample environment had been revised. MIRA now also has a new area detector for SANS and MIEZE measurements (see page 10 of this newsletter).

#### TRISP

The three-axes spectrometer TRISP upgraded for a new dilution cryostat with a cooling power of 400  $\mu$ W at 100 mK which also provides space for large samples, i.e. for high pressure measurements.

#### TOFTOF

As already reported in the FRM II NEWS No.6, the time-of-flight spectrometer TOFTOF had increased its number of detectors from 605 to 1006, resulting in shorter measuring times. Further improvements comprise the new detector electronics and the enhanced electronic shielding which leads to the reduced and more stable background. The insertion of a variably focussing neutron guide was finished.

#### ANTARES

While other instruments have added or improved components, the radiography and tomography facility ANTARES had been completely dismantled. The ANTARES-team removed 550 tons of shielding to make room for the new neutron guide feeding the future guide hall east. This involved

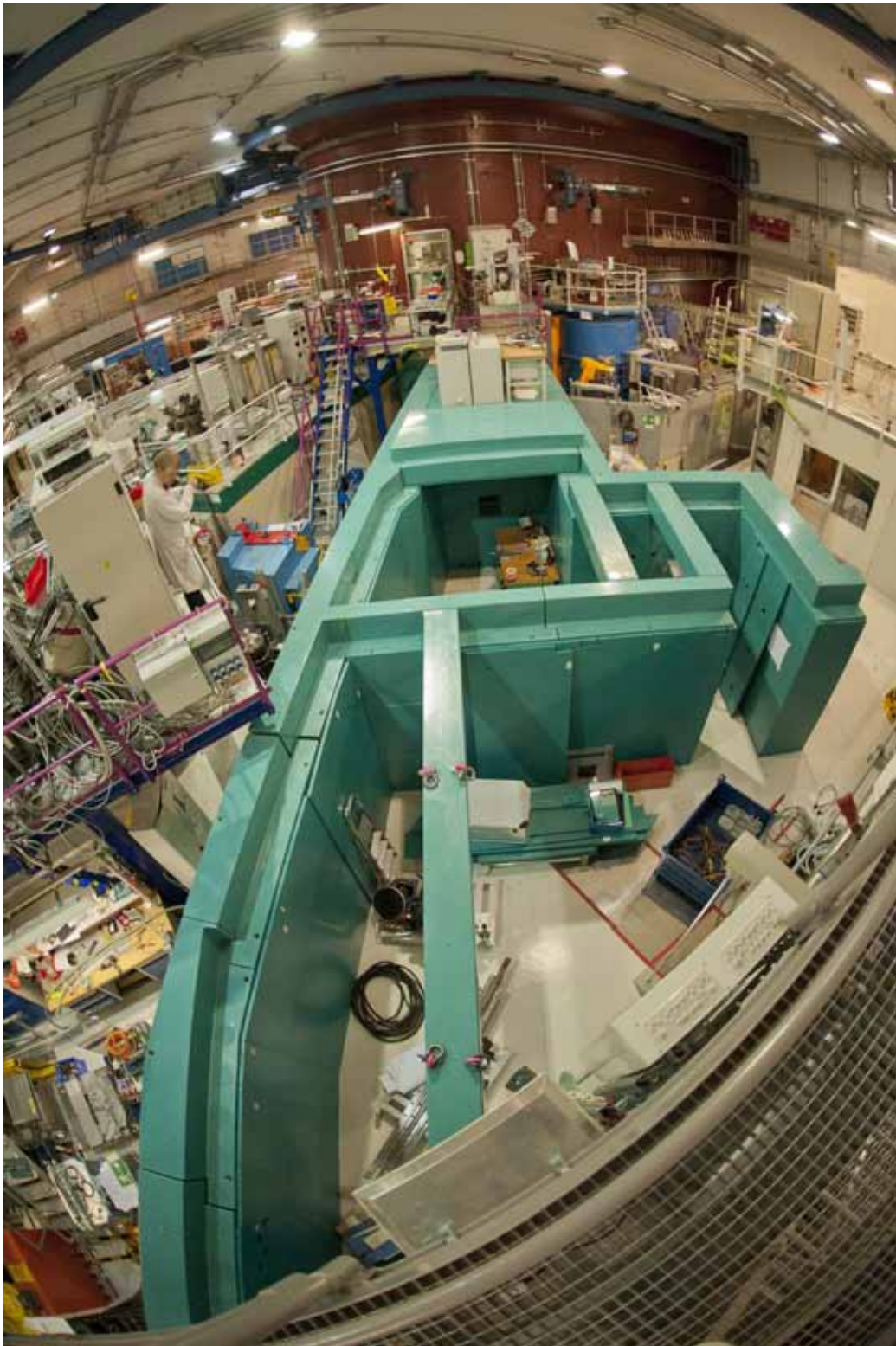

Fig. 3: The new green patented shielding of ANTARES saves weight and space.



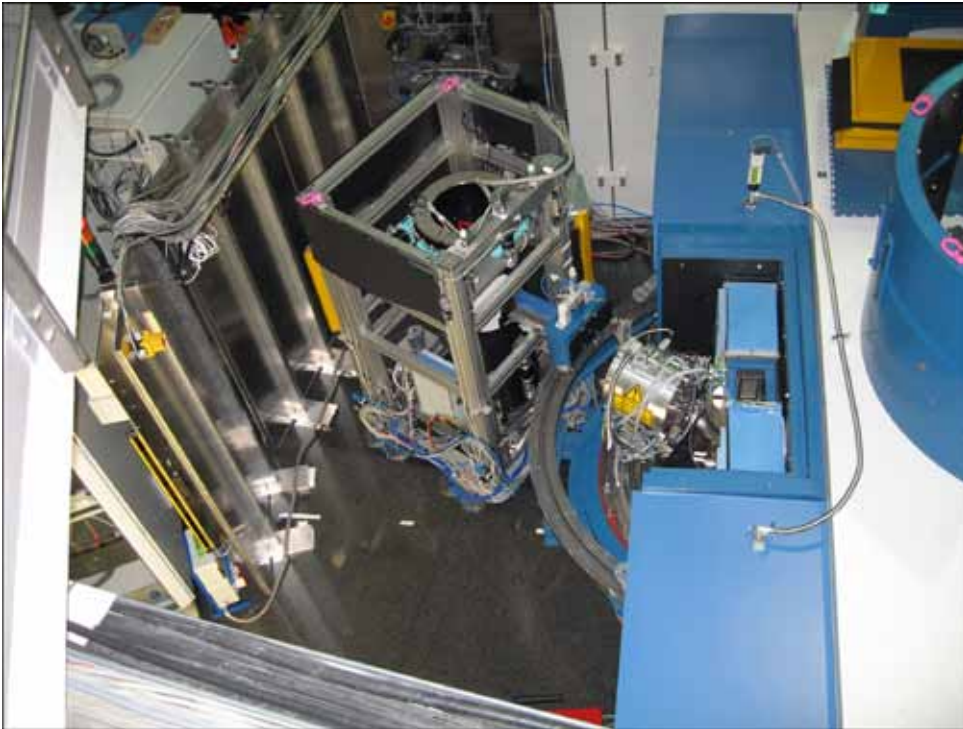

Fig. 4: BioDiff is equipped with an image plate detector and had the first friendly users.

the tear-off of the platform of the positron source NEPOMUC. ANTARES has already filled its new green shielding (fig. 3) using a recyclable shielding material (see NEWS No. 5) and installed it in the experimental hall. The material has and maintains the consistency of wet sand and does not solidify. Since the new material contains only elements contributing to the radiation shielding, the thickness of the shielding can be reduced by 20 % compared to heavy concrete, saving more than 50 tons of weight in the case of ANTARES. Although the initial expense for the shielding material is 10-20 % higher than for conventionally used heavy concrete, it comes cheaper in the long term perspective as it can be reused, saving the original investment, and thus does not cause additional waste disposal costs. The Technische Universität München patented this invention. The old heavy concrete shielding of the ANTARES facility has mostly been recycled: About 200 tons of components will be reused at the neutron facility of the Institut Laue-Langevin (ILL) in Grenoble, and some shielding walls are reused by the FRM II instrument MEPHISTO in the neutron guide hall west.

## BioDiff

The first friendly users have already run measurements at the new BioDiff (see also page 8 of this newsletter). In the maintenance break, it had been equipped with a selector arm, a neutron image plate detector (see fig. 4) and a lens aperture.

The detector and the instrument software were tested successfully.

## RESI

Time saving at the single crystal diffractometer RESI: The new mechanics of the monochromator saves several days of adjustment (see fig. 5). An encoder allows for a fast change of positions. 20 % more flux was achieved by a new adjustment. RESI will soon provide an additional Laue camera. Already prepared are the beam exit and the sample table. The peak integration software of the single crystal diffractometer is

now free for academic use instead of the commercial licence.

*Jürgen Neuhaus, FRM II*



Fig. 5: Faster adjustments are possible at RESI using a new monochromator mechanics.



Did you miss the special issue of the FRM II news published online on the occasion of the restart on October 29<sup>th</sup>, 2011?

You can download it from [www.frm2.tum.de/en/user-office/news-dates](http://www.frm2.tum.de/en/user-office/news-dates)

**FRM II news special issue**

**Back to work on October 29<sup>th</sup>, 2011!**

After the first long maintenance break, Heinz Maier-Leibnitz is back to work. This long period was filled with many new things for the production of neutrons.

- A new thin film for the production of the entire beam tube for the neutron source was designed.
- The new "position fuel" in the neutron source system which delays the neutron source were rebuilt to sustain the two heat exchangers replaced by larger ones.
- The two heat exchangers were replaced by larger ones.
- The POLI, the polarisation instrument, was replaced by the new instrument ANTARES.
- ANTARES, the polarisation instrument, was replaced by the new instrument ANTARES.

Dear colleagues and friends!

A long and painful period without neutrons finally came to its good end. The restart of our facility has been achieved on October 29<sup>th</sup>, 2011, a long maintenance break has been longer time than expected. Minor technical problems had coincided with the disaster in Japan in spring this year. A tremendous amount of work had to be done as a follow-up of the Fukushima accident. Even though the damage of the Fukushima accident had been constructed, the Fukushima accident had been constructed.

**A picture is worth a thousand words**

The old beam tube ER11 in the tank.

Test for cutting up beam tube SR11.

The safety flaps and their inspection.

Students of the JCMS LabCourse - working without neutrons...

Working at the fitting.

Further of SAM our instrument is in the...

RESI: Assembled new monochromators inside the shielding.

New focussing monochromator at MIRA.

BioCR: Instrument scientists Andreas Ostermann and Tobias Schrader are waiting for the first users.

The reactor reached 20MW on October 29<sup>th</sup>, 2011, 14:47.

Martin Fleiter of the reactor staff is also waiting for the start.

KWS-2: High intensity small angle scattering diffractometer is now available!

MARIA: The magnetic reflectometer with high incident angle and instrument start.

PGAA: Instrument scientists Zoltan Rovay and Stefan Solirad prepare everything for the new experiments.

ANTARES: The new green shielding.

**Editors:**  
Flavio Carlucci  
Ina Lommatsch  
Jürgen Neuhäus  
Andreas Voit

**Photos:**  
Many thanks to all contributors!

**Contact:**  
Technische Universität München  
Forschungs-Neutronenquelle Heinz Maier-Leibnitz (FRM II)  
User Office  
Lichtenbergstraße 1  
D-85747 Garching  
Phone: +49 (0)89 289 10794 / 10703  
e-mail: [userinfo@frm2.tum.de](mailto:userinfo@frm2.tum.de)  
[www.frm2.tum.de](http://www.frm2.tum.de)

**New deadline for proposals: January 27<sup>th</sup>, 2012**

[fzj.frm2.tum.de](http://fzj.frm2.tum.de)

[user.frm2.tum.de](http://user.frm2.tum.de)





## 5<sup>th</sup> European Conference on Neutron Scattering

Prague, July 17<sup>th</sup>-22<sup>nd</sup>



Staff members of FRM II, JCNS, HZG and HZB at the ECNS 2011.

The 5<sup>th</sup> European Conference on Neutron Scattering (ECNS) was organised by the Faculty of Mathematics and Physics of the Charles University (Prague) and the Nuclear Physics Institute of the Academy of Sciences of the Czech Republic on behalf of the European Neutron Scattering Association (ENSA).

A total of about 700 participants joined the conference. Coming from 40 different countries, they showed the big interest in topics connected with neutron scattering. Even the ECNS is dedicated to the European users (while the ICNS addresses users worldwide), there were also participants from many non-European countries. 200 talks and more than 500 posters opened countless opportunities to learn about and discuss



Garry Lander (top),  
Christian Rüegg  
(bottom).



new methods, new instruments and new results. The staff of the FRM II and the Helmholtz centres Jülich (FZJ), Berlin (HZB) and Geesthacht (HZG) showed their own scientific results in a total of more than 50 contributions at the ECNS: 20 talks and about 30 posters.

The conference dinner took place in a conference centre opposite of the Hradschin and the view was spectacular, especially when the sun went down! Two scientists were awarded: Christian Rüegg of the PSI received the Erwin Félix Lewy-Bertaut Prize by the ENSA together with the European

Crystallographic Association (EC) for his research in the field of low-dimensional quantum spin systems and quantum phase transitions

Gerry Lander was given the Walter Hälgl Prize

by the ENSA. This was done in order to honour his untiring contributions to develop neutron sources, first and foremost in the field of spallation sources.

In the exhibition area there was a première. For the first time the collaborating FRM II, FZJ, HZB and HZG jointly organised a booth. They sponsored the ECNS 2011 as a platinum partner and stocked the

largest booth of all neutron facilities. Between the

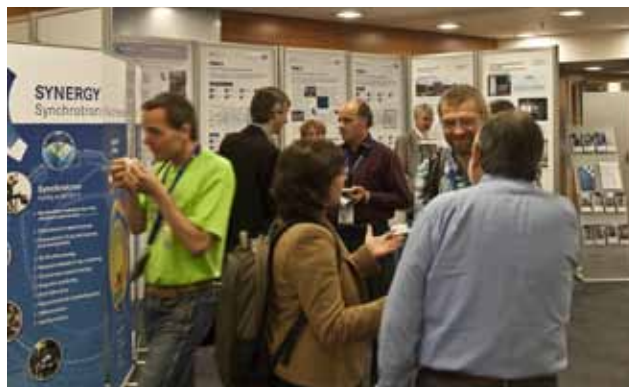

Many visitors at the jointly organised booth.

talks and poster sessions, the booth was crowded. Scientists wanted to know the experimental facilities hosted at the FRM II and at the HZB and how to apply for beam time there. Contacts from the user offices advertised, answered all questions, and were happy to arrange conversations with the responsible instrument scientists. All visitors became very well equipped with brochures, flyers and the first printed version of the FRM II Newsletter. The promotional gifts like pencils, ballpoints and sweets were also well accepted. Because of these positive experiences, the next booth will be organised jointly again!

*Ina Lommatzsch, FRM II*



Vivid discussions during a poster session.

## 4<sup>th</sup> Advanced Summer School SSRDM 2011

München, July 24<sup>th</sup>-30<sup>th</sup>

The 4<sup>th</sup> international Advanced Summer School in Radiation Detection and Measurements (SSRDM 2011) took place in Munich for the first time after having been in Berkeley and Tokyo. The school is jointly organised by the University of California Berkeley, the University of Tokyo, the Technische Universität München and the Max Planck Institute (MPI) for Physics. It is renowned for its high ranking lecturers, who are open for discussions with the participants not only during the lectures but also in the social hour every day providing additional insights into their particular area of research. This summer 60 students had the opportunity to get to know modern concepts of detectors in nuclear and particle physics, neutron research, and their applications in medicine and astrophysics, but there was also time to discuss with the experts about the details of their own research. In between the lectures, the students visited research facilities, such as the FRM II, but also the semiconductor laboratory of the MPI, the MPI for Physics and the nuclear medicine department of the Klinikum rechts der Isar. The unchallenged highlight of the visits was that of the neutron source on July 26<sup>th</sup> and 27<sup>th</sup>.



Karl Zeitelhack, head of the detector and electronics group at the FRM II, who had co-organised the school, guided the students for a tour of the detectors and scientific instruments.

The success of this marathon school, lasting 11 hours per day was visible by the extraordinary performance of the students at the midterm exams. This week spent together, the beautiful weather, the hospitality in Munich and the Bavarian culture made it an unforgettable experience, especially for the students from overseas.

Sponsors of the summer school: University of Tokyo, Nuclear Education and Research Initiative (GoNERI) and the German Federal Ministry for Education and Science (BMBF).

*Roman Gernäuser, TUM*

## 15<sup>th</sup> JCNS LabCourse

Jülich and Garching, September 5<sup>th</sup>-16<sup>th</sup>

In September, the Jülich Centre for Neutron Science (JCNS) organised its annual Laboratory Course Neutron Scattering. As previously, the lab course was held at two locations: first at Forschungszentrum Jülich for the lecture part and then at the neutron source FRM II in Garching for the experiments.

The lab course is open to students in physics, chemistry, and other natural sciences from all around the world. Participation is free of charge for the selected students, and travel expenses are reimbursed for foreign students. The course is part of the curricula of the universities of Aachen and Münster. Funding came from Forschungszentrum Jülich with support from NMI3 (EU framework programme 7), and the European Network of Excellence SoftComp. This year we had 155 applications and accepted 54 students.

The first course's week was dedicated to lectures encompassing an introduction to neutron sources, and presenting scattering theory and instrumentation. Furthermore, selected topics of condensed-matter research were addressed.



In the second week, many instruments at FRM II were made available for students' training: PUMA, SPODI, HEIDI, TOFTOF, RESEDA, TREFF, KWS-1, KWS-2, KWS-3, DNS, J-NSE, SPHERES. These world-class instruments were provided by JCNS, RWTH Aachen, TU Darmstadt, Universität Göttingen, LMU Munich, and TUM.

This year's course was overshadowed by FRM II's long maintenance break. For that reason the experiments could only be performed as 'dry runs'. The students had to use data stored from previous experiments. In most cases, this did not interfere too much with the didactical objectives. The advantage: The absence of radiation allowed the students to see parts of the instruments which in normal operation have to stay behind shielding like neutron guides, monochromators, etc.

The next JCNS laboratory course will take place on September 3<sup>rd</sup>-14<sup>th</sup>, 2012. You are cordially invited to submit applications. In spring 2012, more details will be posted at [www.neutronlab.de](http://www.neutronlab.de).

*Reiner Zorn, FZJ*





## Neutron Scattering for Crystallographers

Salzburg, September 19<sup>th</sup>-20<sup>th</sup>

On the occasion of the combined annual meeting of the DGK (Deutsche Gesellschaft für Kristallographie), DGM and ÖMG (Deutsche resp. Österreichische Mineralogische Gesellschaft) from September, 20<sup>th</sup> until 24<sup>th</sup>, 2011 in Salzburg the DGK's workgroup „Neutron Scattering“ offered a satellite workshop from September 19<sup>th</sup> until 20<sup>th</sup>.

Goal of the workshop focusing on students and scientists of different natural and materials sciences was the presentation of the basics and various methods of neutron scattering as well as their variety of applications.

On the first day altogether 15 participants from ten different universities heard lectures held by Ralph Gilles (TUM), Astrid Schneidewind (HZB), Markus Braden (Universität Köln), Fritz Frey (LMU), Regine Willumeit (HZG) and Martin Meven (TUM). The range of the presented methods covered powder and single crystal diffraction, magnetism, spectroscopy and small-angle scattering, whose versatility was demonstrated with various examples from physics, chemistry, crystallography, material sci-

ences and biology. On the next day the instruments belonging to the different methods were presented

to the participants at a guided tour of the research neutron source Heinz Maier-Leibnitz (FRM II).

Both the broad spectrum of the participants from graduate students to university professors and the numerous questions and discussions following the lectures and even during the guided tour show the large interest in the presented topics.

The workgroup would like to thank the speakers, the DGK, the coworkers of the University of Salzburg and the FRM II. Their support was substantial for the success of the workshop.

*Martin Meven, FRM II*



The natural sciences building of the Salzburg University hosted the satellite workshop „Neutron Scattering for Crystallographers“.

## JCNS Workshop on Neutron Instrumentation

Tutzing, October 4<sup>th</sup>-7<sup>th</sup>



About 80 specialists in neutron instrumentation from Europe, Japan and the USA met in Tutzing in October to discuss the latest „Trends and Perspectives in Neutron Instrumentation: From Continuous to Spallation Sources“. The workshop was organised by the Jülich Centre for Neutron Science (JCNS).

The workshop came at exactly the right time. With new spallation sources being brought into operation in the USA and Japan, as well as the decision to build the long-pulse spallation source in Europe, the focus of neutron instrumentation development has shifted more and more from continuous to spallation sources. The workshop brought together experts in neutron instrumentation at both

continuous and spallation sources to make the most effective use of the knowledge accumulated so far concerning the instruments for construction at the new European spallation source ESS.

Around 50 oral presentations, including five lectures giving an overview of current instrumentation from a selected panel of leading experts worldwide along with a

total of 20 posters, covered all aspects of state-of-the-art and advanced neutron instrumentation. Topical sessions such as those covering „Larmor Precession Instruments“, „Neutron Diffraction“, „Large Scale Instrumentation“, „Instrument Components“ and „Inelastic Instrumentation“ formed the structure of the workshop. JCNS contributed nine oral presentations and ten posters, underlining its key role in future neutron instrumentation, as a centre already possessing a wealth of experience in operating instruments at continuous as well as spallation sources.

The next JCNS workshop focusing on soft matter will be held in Tutzing from October 8<sup>th</sup>-11<sup>th</sup>, 2012.

*Angela Wenzik, FZJ*

## Science Vision for the European Spallation Source

**Bad Reichenhall, October 10<sup>th</sup>-12<sup>th</sup>**

The European Spallation Source ESS will be the next generation European neutron research facility to be built in Lund, Sweden. When it becomes operational in 2019 it will be the most powerful neutron source in the world. At present 17 European countries joined this project which is on the roadmap of the European Strategy Forum on Research Infrastructures (ESFRI).

The German Komitee Forschung mit Neutronen (KFN) organized corporately with the ESS AB and Forschungszentrum Jülich the workshop "Science Vision for the European Spallation Source – German Perspectives". The meeting was held in Bad Reichenhall and over 150 participants from universities, research centres, industry and the ESS AB joined the meeting.

The workshop was intended to present and discuss visions and perspectives for science at this world's premier neutron source which is currently in the design-update-phase. The evaluation of scientific opportunities at the ESS is an important

step for the German neutron community to take part in the design and construction of the ESS and its science. The plenary talks and the parallel sessions covered the full spectrum of relevant scientific disciplines from magnetism, materials science, earth science, and soft matter to biology and chemistry.

The main goal of the workshop was to bring together the German neutron community (one of the largest prospective ESS user groups worldwide), represented by the KFN, with the instrument developers in the German ESS design update project funded by the German Federal Ministry of Education and Research (BMBF).

Thus, the meeting with its fruitful and goal-oriented discussions was a logical and mandatory step to ensure that the ESS, which has been eagerly awaited for so long by the European user community, will be a true science driven facility.

*Andreas Wischnewski, FZJ*

## 496 Happy People at the FRM II Open Day

**Garching, October 15<sup>th</sup>**

After having lined up for half an hour, the young man shows a big smile: Finally he could register for a tour of the neutron source FRM II. Like him, more than 500 people had patiently waited in the long line-up for the registration at the FRM II booth on the open day October 15<sup>th</sup>. Together with 27 other institutions at the research campus in Garching, the FRM II opened to the public offering tours from 10 to 18h.

In the early afternoon, all 29 tours were fully booked. 496 people in total were guided by FRM II staff through the experimental hall, the neutron guide hall, and had a look at the reactor pool. Those being too late for registration were able to visit the talks offered by the neutron source in the physics department. They learned more about the research using anti particles at the positron source by Christoph Hugenschmidt, the tumour treatment using neutrons by Birgit Loeper-Kabasakal, the existing and planned radioisotope production by Heiko Gerstenberg, and the industrial applications by Ralph Gilles. The scientific director of the neutron source, Winfried Petry, gave an insight into research with neutrons, and the technical director Anton Kastenmüller explained the safety features to an interested audience. Films about the FRM II shown in a lecture hall also attracted some visitors. The booth of the radiation

protection group was highly frequented. The reactor accident in Fukushima, Japan, had made people more aware of radioactivity. They were surprised, when they saw the natural sources of radiation presented by the radiation protection responsables Helmut Zeising and Marcel Kaleve, as well as Franz Michael Wagner.

*Andrea Voit, FRM II*

Lining up patiently for at least half an hour to catch one of the tours at the FRM II – no problem for almost 500 people.





## Ferroelectrics, Batteries and Shape Memory Alloys

### In operando diffraction on functional materials

The high-resolution thermal powder diffractometer SPODI at FRM II is primarily dedicated to Rietveld analysis on complex structural and magnetic order phenomena in polycrystalline materials at different conditions. Besides FRM II standard sample environment equipment such as cryostats, furnaces and magnets, a variety of special environment devices are provided to the user community. In this contribution, we report on scientific projects to investigate functional materials using special environmental tools developed for SPODI. The corresponding devices had been developed by the operators of SPODI and their collaborators, but they are available also for user experiments.

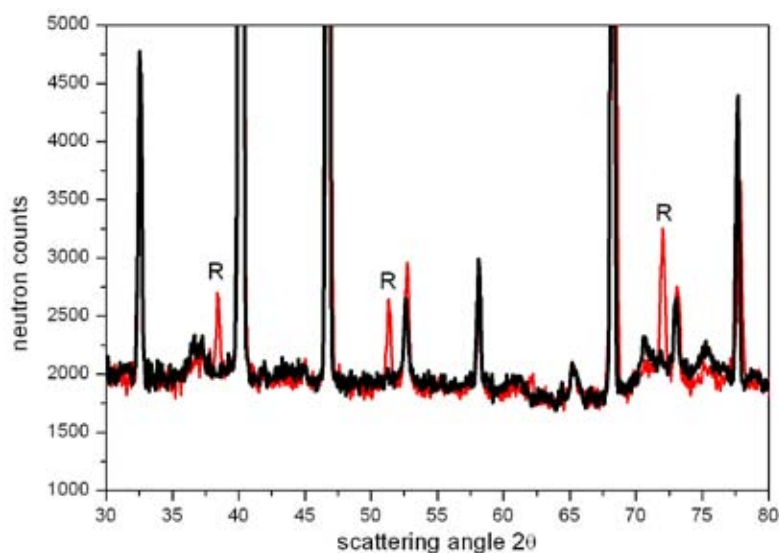

Fig 1: Diffraction patterns of the piezoceramic 92 %  $\text{Bi}_{0.5}\text{Na}_{0.5}\text{TiO}_3$ -6 %  $\text{BaTiO}_3$ -2 %  $\text{K}_{0.5}\text{Na}_{0.5}\text{NbO}_3$  in the initial state and at 6 kV/mm. Additional superlattice reflections appearing under the electric field indicate the partial phase transition to rhombohedral symmetry.

#### Ferroelectrics

The structures of technically relevant piezoceramics are intensively studied by different methods in the group of Hartmut Fuess at TU Darmstadt. In the frame of the PhD work of Manuel Hinterstein (now TU Dresden) a sample holder had been developed to study structural changes under high electric fields. These investigations enable a better understanding of the poling mechanisms occurring in applied piezoceramics with complex composition. Electric fields up to 7 kV/mm (depending on the sample size) can be provided in combination with field directions either vertical to the scattering plane or within the scattering plane. The observed large field induced macroscopic strain in 92 %  $\text{Bi}_{0.5}\text{Na}_{0.5}\text{TiO}_3$ -6 %  $\text{BaTiO}_3$ -2 %  $\text{K}_{0.5}\text{Na}_{0.5}\text{NbO}_3$  can be attributed to a phase transformation during

the poling process. At 6 kV/mm the transition to a rhombohedral phase was identified by the appearance of corresponding superlattice reflections, resulting from a superstructure caused by a collective tilting of the oxygen octahedra around Ti/Zr atoms (fig. 1 and 2). The structural parameters were determined by Rietveld refinement. In lanthanum doped lead zirconate titanate (PZT) samples with different Ti/Zr ratios, different structural changes under the influence of electric fields were identified and described in terms of anisotropic displacement parameters of the lead cations. Systematic changes in the response to the electric field were observed for different compositions across the morphotropic phase boundary.

#### Batteries

The fatigue in lithium ion batteries is one of the most challenging tasks, which has great impact on the current progress of this energy storage technology. Neutron diffraction is very efficient in resolving such issues by probing the structure of constituents (and their evolution upon introduced fatigue) on the micro- and nanoscale. What is more, the evolution of the battery upon charging/discharging and, details of the intercalation processes can be monitored “live” (in operando). For this purpose a multichannel potentiostat VMP3 from BioLogic® is available for different kinds of in-situ or in operando electrochemical sam-

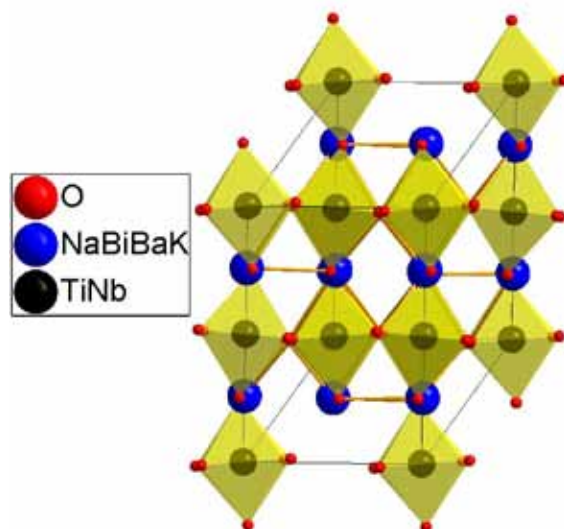

Fig 2: The structure of rhombohedral 92 %  $\text{Bi}_{0.5}\text{Na}_{0.5}\text{TiO}_3$ -6 %  $\text{BaTiO}_3$ -2 %  $\text{K}_{0.5}\text{Na}_{0.5}\text{NbO}_3$ . The superstructure in the tiltings of the oxygen octahedra is the reason for the observed superlattice reflections.

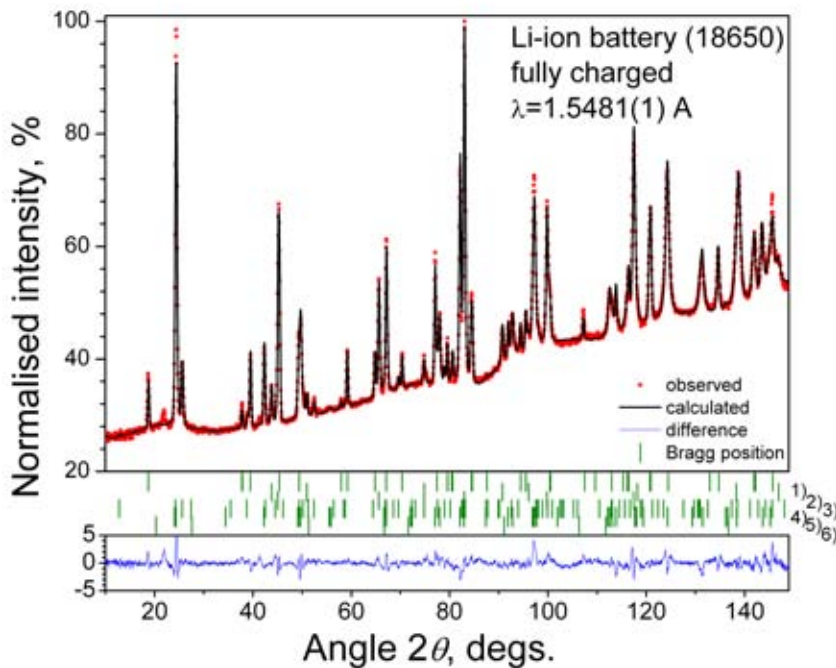

Fig 3: Diffraction pattern and Rietveld analysis of a commercial battery.

ple treatments. An example of a powder diffraction pattern collected for a commercial Li-ion battery of the 18650 type is shown in fig. 3 along with its treatment by full-profile Rietveld method. Clear signals from  $\text{LiCoO}_2$  (cathode), Li-intercalated carbon phases (anode), steel (housing), aluminum and copper (current collectors) can be separated and modelled. Soller collimators in front of every of the 80 detector tubes are peculiar to the SPODI powder diffractometer. This feature yields the high resolution over a broad  $2\theta$  range without any influence by the sample diameter. This feature in combination with efficient data correction algorithms enables an effective use of neutron powder diffraction data. This Li-ion battery research is supported by a DFG transfer project and performed in collaboration with the group of Helmut Ehrenberg (Karlsruhe Institute of Technology and SFB 595 at TU Darmstadt).

### Shape Memory Alloys

A rotatable mechanical materials testing frame (fig. 4) was developed for the diffractometers SPODI and STRESS-SPEC with great contribution from Philipp Jüttner (Mechanical Engineering Office, FRM II) and Günther Seidl (STRESS-SPEC, FRM II). An Eulerian cradle like setup ( $\omega$ ,  $\chi$ ,  $\Phi$  axes) enables the orientation of the load axis with respect to the scattering vector. Tensile and compressive stress up to 50 kN can be applied, and torsion moments up to 100 Nm.

Wolfgang Schmahl and his group at the LMU München investigated the anisotropy in the mechanical response of polycrystalline nickel titanium shape memory alloys. The measurements allow the separation of the anisotropic elastic strain of the material and the anisotropic pseudoplastic strain of the monoclinic martensite phase of NiTi. The pseudoplastic strain is due to the adaption of the ferroelastic twin domain structure to the applied stress and it is the key mechanism for the shape memory. The ferroelastic twinning/detwinning process is measurable as an effect of crystallographic preferred orientation (texture) on the intensity distribution of the neutron diffraction maxima.

The diffractometer SPODI had been built and operated based on BMBF funding by TU Darmstadt and LMU München. Since 2011, SPODI has been driven by the Technische Universität München/FRM II. The instrument scientists Markus Hölzel and Anatolij Senyshyn operate the machine with the assistance of the technician Josef Pfanzelt (all FRM II). Since summer 2011, Martin Muehlbauer and Oleksandr Dolotko (both TU Darmstadt) have joined the SPODI team to advance and apply neutron scattering for the in operando studies on fatigue in Li-ion batteries (supported by DFG).

*Markus Hoelzel, FRM II*



Fig 4: Rotatable tensile rig at diffractometer SPODI.



## High Speed Texture Analysis

### Investigation of texture gradients by the Stress-Spec robot



Fig. 1: Rotary friction welded sample of Al7020 and steel 316L.

Microstructure, residual stress and crystallographic texture are essential parameters for design and interpretation of engineering products. The layout of the residual stress and texture diffractometer Stress-Spec was specially optimised for a combined

investigation, which leads to many different possibilities regarding the experimental setup. Residual stress measurements need a high local resolution while crystallographic texture analysis requires relative high intensities. From the experimental point of view the microstructure studies using peak broadening pole figures are a combination of both. Furthermore, only high flux instruments are suitable for this investigation. All kinds of such investigations have been carried out at Stress-Spec. During many manufacturing processes and joining procedures gradients can be produced in the products. In case of crystallographic textures it means that anisotropic properties are not only related to both the single crystal anisotropy of the material and the present global texture but also to the texture gradient inside the sample. Strong texture gradients can result in strong stress profiles up to a failure in semi-finished products. The robot Stäubli RX160, which is installed at Stress-Spec, is ideally suited for scanning semi-finished products with great freedom.

Eulerian cradles are strongly limited regarding the sample size if x-, y- and z-movement is required to scan large samples. So the maximum weight of samples including a sample holder is 30 kg. It has to be noticed that the sample geometry must be scanned for instance by a laser scanning system, either to specify the measurement grid precisely and for necessary data corrections.

The beam path in the sample will change with each measurement during x-, y-, z- movement as well as during the sample rotation and therefore tilt and especially absorption correction is needed. Three investigated samples were shown in the pictures. The first one (fig. 1) is a rotary friction welded sample of Al7020 and steel 316L. The second one (fig. 2) is a Cu-ring cut from a tube and the third one (fig. 3) is a part of a Cu-tube of 12 kg weight.

Compared to standard texture samples the sample sizes in these cases are much larger.

The friction welded sample was 25 mm in diameter and 160 mm in length. Using a gauge volume of  $2 \times 2 \times 2 \text{ mm}^3$  and a wavelength of  $\lambda=1.68 \text{ \AA}$  the reflections of Al (311) and Fe (311) were measured to get a residual stress profile as well as texture gradients. In case of the Fe-phase the grain size is too large for getting high quality pole figures. Al shows a maximum stress in the heat effect zone close to the weld with about +200 MPa while the maximum stress at the Fe-side was about 10 mm outside the weld having -200 MPa. The texture at the Al-side changes from typical rolling texture as base material to a mixture of rolling texture plus rotational fiber texture. Both residual stress and crystallographic texture depend on the welding parameters such as welding temperature, rotation speed, welding pressure, and time of welding pressure. If needed, possible phase transitions in the welded zone can also be analyzed.

The Cu-tube has an outer diameter of 140 mm and a wall thickness of 10 mm. Due to the tube processing an ovality of about 0.57 % and an eccentricity of about 7.9 % was found within it. A first test was performed successfully using a small



Fig. 2: Cu-ring cut from a tube.

Cu-ring of 11 mm width cut from the tube. Cutting is always problematic for additional stress analysis not to relax residual stresses.

The global texture averaged over the complete wall was measured every  $15^\circ$  around the perimeter with a large primary slit of 15 mm. The exposure time was 10 sec and the sample detector distance was 850 mm. Two detector positions of the  $300 \times 300 \text{ mm}$  area detector were needed to get sufficient number of pole figures for qualitative texture description. The calculation of the orien-

Fig. 3: Part of a Cu-tube of 12 kg weight.

tations distribution function (ODF) shows that the crystallographic texture varies around the perimeter. This means that the material's flow is inhomogeneous around the perimeter, which can be caused either by the initial crystallographic texture before the drawing of the tube or by the parameters of that drawing.

In a second try a 12 kg segment of the Cu-tube with a length of 250 mm was fastened to the robot arm and measured recently. The data analysis is still running. With this tube size both texture gradient and stress profile can be measured with an identical setup.

The automatic mapping of different sample positions including continuous pole figure scanning at each position saves about 30 % beam time. Two more options for additional improvements at Stress-Spec are an increasing detector space and faster detector electronics.

*Heinz-Günter Brokmeier, TU Clausthal*

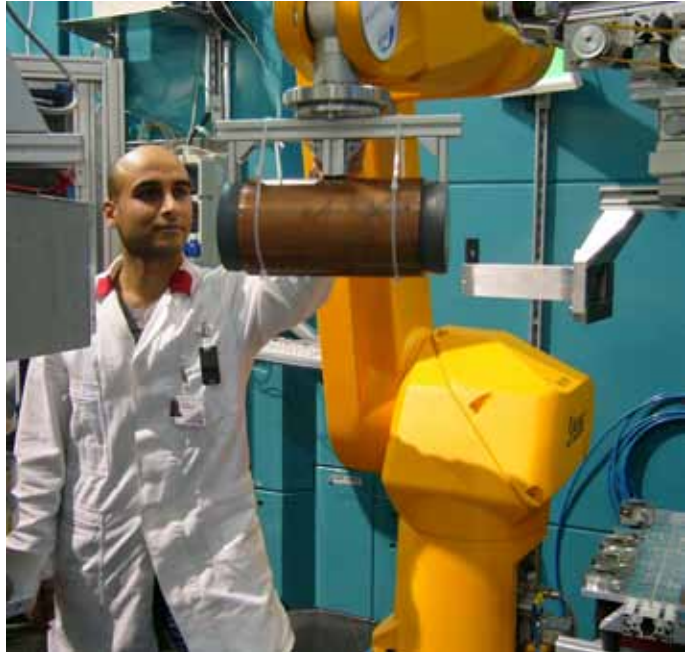

## ERC Grant for Research on Magnetic Vortices

Christian Pfeleiderer of the Physik-Department of TU München has been awarded an Advanced Grant of the European Research Council for the investigation of complex spin structures. The five-year project, "Topological Spin Solitons for Information Technology", will receive 2.2 Mio€. It aims to explore which materials and structural material classes display novel magnetic properties with non-trivial topological properties. In this quest, Pfeleiderer plans to use the state-of-the-art instrumentation at the Heinz Maier-Leibnitz neutron source extensively. Pfeleiderer thereby seeks to identify new physical properties and to study their potential for applications in information technology and related fields.

The ERC project of Christian Pfeleiderer and his team builds on the discovery of a new form of magnetic order consisting of magnetic vortices, so-called skyrmions, in 2009, using neutron scattering at the FRM II. While this work already triggered great interest across the scientific commu-



Christian Pfeleiderer (left) and Florian Jonietz (right), doing measurements at MIRA.

nity, it was recently followed by a second even more remarkable observation. Using again neutron scattering at the instrument MIRA, the same team showed that the magnetic vortices began to move under the application of very low electric current densities. This has generated great interest in these new types of magnetic vortices as a possible route to applications, in particular for information technology.

Christian Pfeleiderer works in the field of experimental solid state physics. His research is devoted to the systematic search and identification of new material properties driven by strong electronic correlations. Examples of this include new forms of magnetic order, unconventional superconductivity, and anomalous metallic states. The experimental

methods used in these studies comprise single-crystal growth of intermetallic compounds under ultra-pure conditions, measurements of transport and volume properties under extreme conditions, and a wide spectrum of neutron-scattering techniques.

*Andrea Voit, FRM II*



## ESMI

### Top Level Infrastructure for the European Soft Matter Community



ESMI bundles infrastructure from 22 research groups in 17 partner institutions which are located in 10 different European countries.

The FP-7 project **E**uropean **S**oft **M**atter **I**nfrastructure (ESMI), which started off in January 2011 was founded with the aim to provide an interdisciplinary infrastruc-

ture in the areas of “soft nanotechnology” and soft matter materials research, where access to a broad range of experimental techniques, synthesis laboratories and computer facilities is offered free of charge to the community of European soft matter scientists. For this purpose, ESMI bundles top-level scientific infrastructure of 22 research groups in 17 partner institutions from ten different countries, among them four industrial partners on three platforms. The experimental platform will allow scientists to use experimental techniques which are not available in their home laboratories, the synthesis platform provides expertise for the development of new soft matter systems, and the supercomputing platform supports access to one of the most powerful European computer facilities for the modelling of soft matter systems. Users of the ESMI infrastructure will receive support from ESMI scientists in conducting their research.

The ESMI experimental platform pools instrumentation for soft matter research, comprising a broad variety of commercial apparatus like light scattering instruments or rheometers as well as unique, highly specialized equipment like a fast confocal rheo-imaging set-up. The platform offers an assembly of scattering (neutrons, X-rays and light) and microscopy (light and electron) facilities, spectroscopic (dielectric and NMR) methods and mechanical (rheology) techniques which represents a comprehensive toolbox for the experimental investigation of soft matter systems.

The ESMI synthesis platform combines three laboratories with different specializations for the synthesis of soft materials. The systems offered span a wide range of specially-designed colloidal particles including metallic and semiconducting nanoparticles as well as carbon nano-tubes. Sophisticated polymer architectures like ring and star shaped macromolecules can be synthesized as well as standard systems. Complementary to the synthetic facilities, in these laboratories, high standard analytical tools are available, which enables this platform to provide well-characterised soft matter systems tailored for the specific needs of the ESMI user.

The ESMI supercomputing platform provides access to the JUROPA supercomputer located at Forschungszentrum Jülich, where the soft matter community can run simulations on a larger scale or perform efficient interpretation of numerical data. For applications, a large number of software packages is on offer. Besides standard numerical libraries, simulation software is available for classical molecular dynamics, ab initio molecular dynamics or DFT and ab initio calculations. If necessary, users of the EMI supercomputing platform may apply for scientific support, which is provided by the Jülich supercomputing center simulation laboratories.

All soft matter scientists within the EU are welcome to apply for access to the infrastructure offered by ESMI by submitting a proposal via the ESMI web portal ([www.esmi-fp7.net](http://www.esmi-fp7.net)). Proposals will be evaluated in a two step process concerning formal eligibility and scientific quality. According to the ESMI eligibility criteria the main proposer and the majority of the proposer team must work in an institution established in an EU member state or in an associate state. Further the main proposer and the majority of the proposer team must work in a country other than that one where the legal entity operating the infrastructure is established. Finally and most importantly, users must disseminate the foreground generated with the ESMI support.

To guarantee high scientific standard of the proposed research, formally eligible proposals will be evaluated by the scientist in charge of the requested infrastructure and by two members of the ESMI review panel which consists of internationally renowned experts in the field.

After a proposal is accepted, all expenses associated with the use of the ESMI infrastructure, including travel, accommodation and subsistence costs will be covered by the ESMI project. This funding is possible thanks to financial support from the EU of 7.8 Mio€ over the project period of four years.

Joint research activities among ESMI partners aim to develop new experimental techniques, synthesis routes and computer simulation algorithms, in an interactive fashion with users, in order to expand the infrastructure capabilities, share expertise and increase the usability.

The project is rounded off by a gender equality programme, designed to promote the participation of women in soft matter science and a networking programme for disseminating knowledge and educating the next generation of soft matter scientists.

*Peter Lang, FZJ*

## Staff Exchange

It is a pilot scheme. If it works out well, more people could follow the example of Elisabeth Jörg-Müller and Eliane Joly. The two women swapped places: Eliane Joly came from the finance and purchasing service at the Institut Laue-Langevin (ILL) in Grenoble to the FRM II in Garching. Elisabeth Jörg-Müller, scientific secretary at the neutron source in Garching, took over at the ILL. During three months, they have worked at the other woman's place, in another country and in a foreign language. In November, they reported about their experiences in a telephone conference.



Elisabeth Jörg-Müller of FRM II at ILL.

*How did you get the idea to have this exchange?*

**E. Jörg-Müller:** When the ILL steering committee met in Munich in 2009, I thought about the possibility for the first time. The scientific director of FRM II, Winfried Petry, and the ILL's former director Richard Wagner have been very supportive to this idea. So, I was very happy to hear that both Mr. Guérin, head of the finance department, and his assistant, Eliane, who had already spent a couple of years in Germany, agreed to participate in this project.

**E. Joly:** I was immediately enthusiastic when Mr. Guérin told me about the staff exchange with Prof. Petry's office, and Prof. Wagner asked me if I would like to go for a few months to FRM II in Garching.

*You both speak the other language almost perfectly. Do you still learn?*

**E. Joly:** I am very glad to speak German every day and even if I am fluent (I had worked in Germany for almost 15 years, before going back to France seven years ago), I still improve my knowledge.

**E. Jörg-Müller:** I have been to France several times and I still learn a lot. I can refresh and update my French. But it is equally interesting to get insight into somebody else's work and see



Eliane Joly of ILL at FRM II.

your own job from a little distance.

*Your work is not entirely the same: Mrs. Joly works at the finance department of the ILL, Mrs. Jörg-Müller as the secretary to Professor Petry.*

**E. Jörg-Müller:** Eliane prepared an exhaustive description, what to do in the different cases. I was

well prepared and I can always ask my colleagues at the ILL.

**E. Joly:** I also got a detailed work description from Elisabeth and can count on very cooperative colleagues. Furthermore it is very interesting to gain insight into the scientific office management of a German neutron source.

*What are the differences apart from the work places?*

**E. Joly:** FRM II stands in close contact with the Technische Universität München and is located on a big research and academic campus.

**E. Jörg-Müller:** The ILL is a European research facility, so you can hear a lot of different languages. Information of general importance is communicated in three languages: English, French, German. The colleagues at my department go for lunch every day in a group. This creates a very familial work atmosphere.

*Do you use your leisure time to explore the other country?*

**E. Jörg-Müller:** I have come here by car. So I use it on weekends to explore the region around Grenoble. It is marvellous to have the mountains right at your doorstep.

**E. Joly:** I have been visiting some places in and around Munich (the castle at Herrenchiemsee and the Bavarian State Exhibition on King Ludwig II, the English Garden, the Nymphenburg Castle ...). And I often go to Munich to meet friends from the time back when I was working in the area.

*Interview: Andrea Voit, FRM II*



## Newly Arrived

### User Office

#### Flavio Carsughi

Phone:  
+49.(0)89.289.10703  
Email:  
[f.carsughi@fz-juelich.de](mailto:f.carsughi@fz-juelich.de)



#### What are you doing at the FRM II?

I am working at the FRM II User Office where we manage a large number of proposals with about 1000 visits per year. I am very happy to serve the neutron community and contribute with my organisational skills to the success of the facility.

#### What are your special interests?

I have a special link to the neutron world, as I scattered the first neutrons during my degree thesis in 1986.

I got my PhD in 1992 at the RWTH, Aachen, Germany, and I have published 70 scientific papers in peer-reviewed journals.

For my investigations I have applied small

angle neutron scattering in many different fields, with a special emphasis on data treatment.

#### What did you do before?

Parallel to my scientific career, about 10 years ago, I had the chance to enter the project management world by joining the European Spallation Source Central Project Team. I found that experience very interesting and I have started to devote always more

and more time to the project management.

Since 2004 I am the project manager of the Soft-Comp Network of Excellence and was deeply involved in building up the European Soft Matter Infrastructure project, both projects granted by the EU.

#### What do you think will be the most challenging within your new job?

The work at the User Office is very complex and includes a number of management tasks. They are all more or less challenging, but the ultimate challenge is running the User Office smoothly and efficiently.

I am proud to work at FRM II and am looking forward to a brilliant future of the facility!

I am instrument scientist for the new polarized neutron three-axes spectrometer KOMPASS at the FRM II. Before I had worked at the Helmholtz-Zentrum Geesthacht in collaboration with the cluster of excellence 'Nano-Spintronics' in Hamburg.

During my PhD at the ILL I studied magnetic excitations in magnetic multilayer structures of the rare-earths. Magnetic dynamics and interactions in correlated electron systems of reduced dimensions since form the core of my scientific interests.



### KOMPASS

#### Alexander Grünwald

Phone:  
+49.(0)89.289.10754  
Email:  
[gruenwald@ph2.uni-koeln.de](mailto:gruenwald@ph2.uni-koeln.de)

### Scientific Directorate

#### Connie Hesse

Phone:  
+49.(0)89.289.11755  
Email:  
[connie.hesse@frm2.tum.de](mailto:connie.hesse@frm2.tum.de)



I am the scientific assistant of the scientific directorate.

After my study of "Applied Natural Science" in Freiberg I did my PhD in immunology in Erlangen. For a six month period I went to Aberdeen as a postdoc.

Why am I really happy to be here? - I am interested in natural sciences and the diversity of interdisciplinary research at the FRM II is very exciting. I am interested in people and I will surely deal with lots of people. Finally I am interested in organization and administration... so here I am.

## Newly Arrived

### Reactor Department

#### Axel Pichlmaier

Phone:  
+49.(0)89.289.14739  
Email:  
[axel.pichlmaier@frm2.tum.de](mailto:axel.pichlmaier@frm2.tum.de)



Although still co-coordinating projects in the science field I am in the process of switching to operations “Fachbereich Reaktorbetrieb”. Before joining the FRM II, I was working for the TÜV as expert in the reactor physics department. I mainly dealt with questions concerning nuclear/reactor physics in Bavarian nuclear power plants. Before that I had worked at PSI, Los Alamos and the ILL. My roots, however, lie in the TUM and the Atomic Egg.

By education I am a physicist and worked mainly in fundamental physics using ultra-cold neutrons.

I am second instrument scientist of the KWS-2 operated by JCNS.

Previously I was the responsible for the “Yellow Submarine” SANS diffractometer at the Budapest Neutron Centre. During the past years my research topic was the study of intermolecular interactions and formation of molecular aggregates in aqueous solutions of small molecules.

I am interested in structural studies on biological and polymeric hydrated membranes.



### KWS-2

#### Noemi Szekely

Phone:  
+49.(0)89.289.10739  
Email:  
[n.szekely@fz-juelich.de](mailto:n.szekely@fz-juelich.de)

### NREX

#### Olaf Soltwedel

Phone:  
+49.(0)89.289.14769  
Email:  
[olaf.soltwedel@frm2.tum.de](mailto:olaf.soltwedel@frm2.tum.de)



I am an instrument scientist at NREX, especially for soft matter experiments.

During my time as PhD-Student I investigated vertical and lateral stabilities of thin organic layers made of polyelectrolytes (PE). After finishing my PhD in Greifswald University I moved to FRM II.

Due to my scientific background I am very interested in physical mechanisms which lead to a buildup of PE-multilayers and how the buildup can be manipulated specifically.

I am the responsible scientist for the **Ultra-Cold Neutron Laboratory (UCN-Lab)** at the FRM II, consisting of the UCN source, and experiments researching fundamental properties of the neutron, e.g. such as its lifetime or a possible electric dipole moment.

Before that, I was a postdoc at the Physics Department E18 of the TUM, mainly focusing on superthermal UCN production mechanisms with cryo-crystals.

My scientific interests are the fundamental properties of the neutron, and their implications on the physics standard model and beyond.



### UCN-Lab

#### Andreas Frei

Phone:  
+49.(0)89.289.14260  
Email:  
[andreas.frei@tum.de](mailto:andreas.frei@tum.de)



## First Work Experience at a Neutron Source

Claudio Polisseni (21), Imperial College, London



Claudio Polisseni (r.) in front of his self-constructed spin flipper together with his supervisors Philip Schmakat (l.) and Georg Brandl at the instrument MIRA.

I am participating in the DAAD – RISE program (Deutscher Akademischer Austauschdienst – Research internships in Science and Engineering), which is an exchange program for British, American and Canadian students in the fields of biology, chemistry, physics, earth sciences and engineering. Undergraduate students are matched with doctoral students at top research institutions across Germany. Basically, I came to work on a 10-weeks internship in this great German research institute FRM II. I am originally from Italy, but I study physics at the Imperial College in London and I am really interested in neutron or more generally nuclear science. It might be too early to tell, since I have just finished my second year in my undergraduate studies, but I might even apply for a PhD at the FRM II, since it is a very nice place with very interesting science projects.

During my internship at the FRM II, I built a spin flipper for the instrument MIRA in the neutron guide hall west. I built it from scratch, so had to design it using an engineering design program, run some simulations, order the components and finally build it. That was very exciting for me: I could do most of the things by myself, but I only had to pick up the phone to get some help. My supervisors were Georg Brandl, PhD-student at MIRA, Jonas Kindervater, PhD-student at RESEDA, and Philipp Schmakat, PhD-student at ANTARES, who all work at the neutron source. It was their idea to offer the internship at the DAAD – RISE program to build the spin flipper at MIRA.

When I applied for the project, I did not know, if I would be selected. 1600 applicants were concurring for 306 internships. But finally, I was lucky to be awarded an internship, probably because of my good grades.

I feel almost like in a family. We go to lunch together every day since I came here to Garching in July. And I also like the work here. I hope to get back some day to be able to test the spin flipper at MIRA, when neutrons are available. I really

enjoy getting to know the German culture and the language. And of course, I hope I can build up a relationship with the researchers here for my later work in science.

Applications for RISE 2012 for Undergraduates are possible from December 6<sup>th</sup>, 2011 to January 31<sup>st</sup>, 2012.

*Protocol: Andrea Voit, FRM II.*

Web-Link to the DAAD RISE program:  
[www.daad.de/rise/en/index.html](http://www.daad.de/rise/en/index.html)



## Excellence Times Three

### FRM II trainees awarded for their apprenticeships

Three trainees of the FRM II were awarded for their excellent grades in the final exam. Alexander Lenz and Christoph Kick finished their apprenticeships at the in-house IT group with grade 1. Josef Waronitza at the FRM II workshop also finalized his school training in mechatronics with the best possible grade.

Josef Waronitza will continue to work at the FRM II reactor division to perform recurring checkups at the Atomic Egg. During his apprenticeship with the head of the workshop Uwe Stiegel, the 27-year-old also worked on the spectrometer PANDA and constructed a new control cabinet for the waste water system of the Atomic Egg. He was fascinated by the variety of his duties at the neutron source: The work pieces which he was to construct were tiny components as the auto focus of a camera for the neutron tomography facility ANTARES up to large components as a cooling water pump for the FRM II. Josef Warnoitza finalized as one of the best apprentices of the Technische Universität München in the year 2011 and was honoured with prize money. His school in Munich also awarded a prize to him.

IT- trainee in application development, Alexander Lenz, had developed programmes for the x-ray laboratory and software for the steering of the engine at FRM II instruments during his 3-year apprenticeship. "It was fun to see the engine reacting directly to my codes", says Alexander Lenz The Technische Universität München awarded him as one of the best trainees of the year. The 19-year-old stays with the FRM II software group to assist the change from TACO to TANGO instrument software.

Christoph Kick will continue his education at an

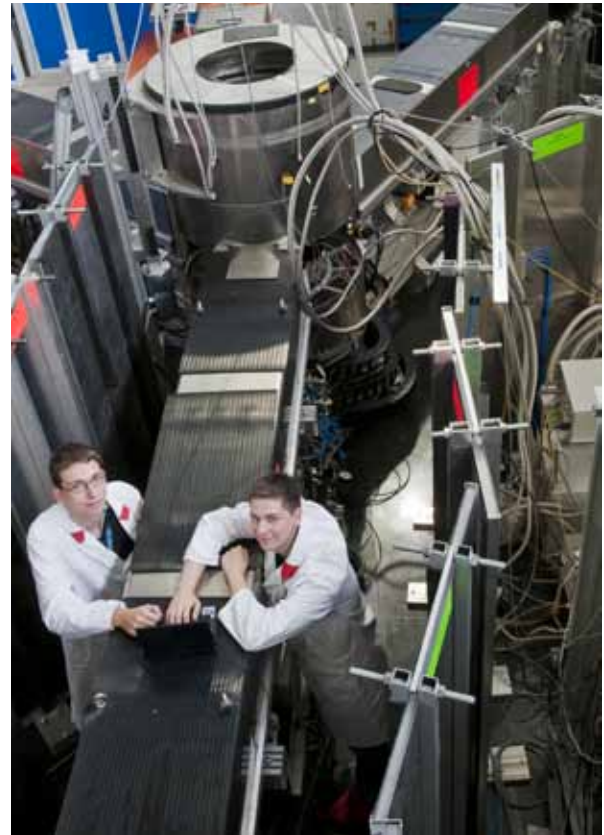

Alexander Lenz (right), apprentice for IT software, and Christoph Kick, apprentice for IT service, at the instrument RESEDA in the neutron guide hall west.

upper vocational school in Straubing. He supported the IT services group during his apprenticeship and helped network and system administrator Jörg Pulz with the extension of the FRM II network service and the administration of the servers. The implementation of the newly planned Voice over IP system for telephones was one of his further

tasks. Christoph Kick was honoured by his school in Freising for his very good grades. His goal is to study informatics at the Technische Universität München.

FRM II-instructor and head of the FRM II software group Jens Krüger, praises the two IT-apprentices Alexander Lenz and Christoph Kick for their excellent grades and wishes them all the best for their future.

*Andrea Voit, FRM II*



A driver's licence for a ground conveyor was also included in the apprenticeship for Josef Waronitza.





*Participate in the future of neutron research:  
Propose your needs and ideas*

—  
*Get involved!*

## Neutron facilities are working for their users!

For the whole user community it is a great pleasure to see FRM II back in operation since October 29<sup>th</sup>, 2011. Congratulations to the reactor operation group and the other teams involved who altogether did a great job! It was now for more than one year that both national sources have not been in operation - this results in the postponement of many research projects and scientific programs. It was very important for the German neutron community to have at least one of the sources back in operation and the next goal will be the restart of BER II in spring next year.

The end of the long maintenance break of the FRM II came along with the constitution of the 9<sup>th</sup> **Komitee Forschung mit Neutronen (KFN)** on October 12<sup>th</sup>, 2011. The first need of the elected members Richard **Dronskowski** (infrastructure and instrumentation), Thomas **Hellweg** (deputy chairman), Regine **von Klitzing** (education and public relations), Georg **Roth**, Andreas **Schreyer**, Oliver **Stockert**, and Tobias **Unruh** (chairman) is to thank the 8<sup>th</sup> KFN for its distinguished work which has finally been manifested in the strategy paper published in July this year (please order your personal copy by mailing to [kfnadmin@physik.uni-kiel.de](mailto:kfnadmin@physik.uni-kiel.de)). Supporting the facilities according to the strategic recommendations given in this paper will be a guidance for the work of the new committee. It will be one of the most important tasks to encourage neutron users to express their needs and ideas and strongly support a corresponding visible consideration in the conception and further development of neutron instrumentation.

The ESS update project is in full swing and the workshop “Science Vision for European Spallation Source” in October in Bad Reichenhall was the startup for the involvement of German users. The next very important milestone on the way to ESS will be the Science and Scientists Meeting to be held in Berlin on 19-20 of April 2012 which will be followed by workshops between May and September 2012 dedicated to the different instrument classes. At these conferences conceptual proposals for instruments can be presented and will be discussed.

I strongly encourage every scientist interested in neutron experiments to contribute to both the proposals and the discussion. This is the chance of the user community to get involved in the decisions and to contribute to new innovations concerning the next generation neutron instruments. A serious discussion about mechanisms to integrate the successful model of BMBF-Verbundforschung in this process will be initiated. In this context it is essential to inspire and attract new user communities for our intriguing field of research. Therefore, I ask you to refer potential neutron users to the upcoming German Neutron Scattering Conference 2012 in Bonn and to the ICNS 2013 in Edinburgh.

I wish you and your family a peaceful beginning of the new year, for seeing you in the best health next year at the ESS meeting in Berlin.

Tobias Unruh  
Chairman of the 9<sup>th</sup> Komitee Forschung mit Neutronen (KFN)  
[Tobias.Unruh@physik.uni-erlangen.de](mailto:Tobias.Unruh@physik.uni-erlangen.de)



## Warm Invitation to all our Users!

### 4<sup>th</sup> User Meeting at the FRM II on March 23<sup>rd</sup>, 2012

**Heinz Maier-Leibnitz Neutron Centre**  
**4<sup>th</sup> User Meeting at the FRM II**  
 March 23<sup>rd</sup>, 2012 - Garching

**Foster and maintain contacts to instrument scientists and other neutron users.**

We kindly invite our past, present and future users to present results and discuss projects at the FRM II. Contributions from very recent measurements or experiments performed before the long maintenance break are welcome. New opportunities to undertake fascinating science at new or upgraded instruments will be presented.

**Registration and Submission**  
[www.frm2.tum.de/user-meeting-2012](http://www.frm2.tum.de/user-meeting-2012)

Oral presentations will be selected out of the submitted abstracts. The poster session in the afternoon will enable detailed discussions on your scientific projects and provide ample information about new opportunities for neutron research at the FRM II.

[workshop@frm2.tum.de](mailto:workshop@frm2.tum.de)

**Dates and Deadlines**  
 Submission of contributions  
 February 3<sup>rd</sup>, 2012  
 Final registration  
 February 24<sup>th</sup>, 2012

**Preliminary Schedule**  
 Scientific talks  
 starting at 09:00  
 Poster session with buffet  
 starting at 17:00

User Office  
 Forschungs-Neutronenquelle  
 Heinz Maier-Leibnitz (FRM II)  
 Technische Universität München  
 Lichtenbergstraße 1  
 85748 Garching, Germany

The FRM II is back to work since October 29<sup>th</sup>, 2011 and we at the User Office are very happy to welcome back our users!

In order to celebrate this and to provide the opportunity to foster and maintain contacts to instrument scientists working at the FRM II and other neutron users, we like to invite you to the upcoming 4<sup>th</sup> User Meeting at the FRM II. It will take place at the Physics Department of the Technische Universität München at Garching on March 23<sup>rd</sup>, 2012.

You are warmly invited to register for this meeting and to submit an abstract. A programme committee will select some abstracts as oral presentations, while the remaining ones will be shown during the poster session in the late afternoon. Bavarian fingerfood will help to encourage fruitful discussions.

Please find all details, register and submit your abstract at

[www.frm2.tum.de/user-meeting-2012](http://www.frm2.tum.de/user-meeting-2012)

In case you have any questions, don't hesitate to send an email to

[workshop@frm2.tum.de](mailto:workshop@frm2.tum.de)

*Ina Lommatzsch, FRM II*

## Upcoming User Survey

The FRM II always strives for an improvement of the user services. One important topic is the sample environment. In order to optimise it we kindly ask you for your cooperation.

In the beginning of 2012, we will start a user survey. Each user who did experiments at the FRM II will get an email with a link to an online form with the request to fill it in after his visit. There will be some general questions regarding the sample environment but the most interesting are the experiment related ones. We would like to know in detail which parameters you needed, which environments you used, how satisfied you were for example with the sample handling, whether the training was sufficiently done etc.

Please note that we need your feedback. Therefore we kindly ask you to invest a few minutes in completing the survey.

We look forward to getting your answers and like to present a first evaluation in our next newsletter!

*Flavio Carsughi, JCNS*

## Reactor Cycles 2012

Cycle	Start	End
<b>27</b>	24.01.2012	23.03.2012
<b>28</b>	17.04.2012	15.06.2012
<b>29</b>	31.07.2012	28.09.2012
<b>30</b>	23.10.2012	21.12.2012

## Proposal Deadlines 2012

Round	Deadline	Review
<b>FRM II 14 JCNS 10</b>	27.01.2012	08./09.03.2012
<b>FRM II 15 JCNS 11</b>	20.07.2012	06./07.09.2012





## Dear users of FRM II and JCNS,

you are invited to apply for beam time at the German neutron source Heinz Maier-Leibnitz (FRM II).

**Deadline for proposals: January 27<sup>th</sup>, 2012**

**Due to extensive rebuilding, ANTARES offers reduced beam time and NEPO-MUC (positrons) is not yet available!**

Just **register** at the digital user office. With your personal account you can access the proposal and reporting system. Have a look at

[www.frm2.tum.de/en/user-office](http://www.frm2.tum.de/en/user-office)

for additional information and guidance to perform experiments at the FRM II.

**Please note:** The beam time on the instruments of the JCNS facility hosted at the FRM II neutron source in Garching are distributed through the JCNS proposal system.

Proposals have to be submitted via the web portals within your personal account

- for FRM II instruments: [user.frm2.tum.de](http://user.frm2.tum.de)
- for JCNS instruments: [fzj.frm2.tum.de](http://fzj.frm2.tum.de)

They are **reviewed** twice a year. The next **review** will take place on March 8<sup>th</sup>-9<sup>th</sup>, 2012. Results of the review panel meeting will be online about two weeks later.

The FRM II is a partner in the EU supported network of European neutron facilities (**NMI3** in FP7). Researchers working in EU Member States or Associated States other than Germany can **apply for travel and subsistence reimbursement**. Please find all details at

- for FRM II instruments: [www.frm2.tum.de/en/user-office/nmi-3](http://www.frm2.tum.de/en/user-office/nmi-3)
- for JCNS instruments: [www.jcns.info/NMI3/](http://www.jcns.info/NMI3/)

Researchers working at German universities can apply for travel and subsistence reimbursement granted by the FRM II, JCNS, HZB and HZG. Please have a look at

[www.frm2.tum.de/en/user-office/financial-support](http://www.frm2.tum.de/en/user-office/financial-support)

To ensure the feasibility of the proposed experiment please contact the instrument scientist in advance.

Furthermore you can apply for CRG beam time at JCNS instruments at ILL and SNS for German users. For more information about this please refer to

[www.jcns.info/jcns\\_proposals](http://www.jcns.info/jcns_proposals)

In addition to beam tube experiments irradiation facilities are available for neutron activation analysis, isotope production and silicon doping.

Call for proposals: Next deadline Januar 27<sup>th</sup>, 2012



**FRM II**  
Forschungs-Neutronenquelle  
Heinz Maier-Leibnitz

[user.frm2.tum.de](http://user.frm2.tum.de)

**Diffraction**

**BIODIFF**

diffractometer for large unit cells; cold source

**MIRA**

multi purpose diffractometer; cold source

**RESI**

single crystal diffractometer; thermal source

**SPODI**

powder diffractometer; thermal source

**STRESS-SPEC**

material-science diffractometer; thermal source

**Particle Physics**

**MEPHISTO**

neutron beam port for particle physics; cold source

**Reflectometry**

**NREX**

polarized neutron reflectometer; cold source

**REFSANS**

time-of-flight reflectometer; cold source

**Spectroscopy**

**PANDA**

three-axes spectrometer; cold source

**PUMA**

three-axes spectrometer; thermal source

**RESEDA**

resonance spin-echo spectrometer; cold source

**TOFTOF**

time-of-flight spectrometer; cold source

**TRISP**

three-axes spectrometer with spin-echo; thermal source

**Radiography**

**ANTARES**

radiography and tomography; cold neutrons

**NECTAR**

radiography and tomography; fission neutron source

**PGAA**

prompt gamma-activation analysis; cold source



[fzj.frm2.tum.de](http://fzj.frm2.tum.de)

**Diffraction**

**BIODIFF**

diffractometer for large unit cells; cold source

**HEIDI**

single crystal diffractometer; hot source

**KWS-1**

high intensity small angle scattering diffractometer; cold source

**KWS-2**

small angle scattering diffractometer; cold source

**KWS-3**

very small angle scattering diffractometer; cold source

**POLI**

polarized hot neutron diffractometer; hot source

**Spectroscopy**

**J-NSE**

neutron spin-echo spectrometer; cold source

**DNS**

polarized diffuse neutron scattering; cold source

**SPHERES**

back-scattering spectrometer; cold source

**Reflectometry**

**MARIA**

magnetic reflectometer with high incident angle; cold source





## Upcoming

### January 29-February 1, 2012

Neutrons and Food 2012  
(Delft, The Netherlands)  
[neutronfood.tudelft.nl](http://neutronfood.tudelft.nl)

### February 08-16, 2012

32<sup>nd</sup> Berlin School on Neutron Scattering  
(Berlin, Germany)  
[www.helmholtz-berlin.de/events/neutronschool](http://www.helmholtz-berlin.de/events/neutronschool)

### March 05-16, 2012

43<sup>rd</sup> IFF Spring School Scattering Methods for  
Condensed Matter Research: Towards Novel Ap-  
plications at Future Sources  
(Jülich, Germany)  
[www.iff-springschool.de](http://www.iff-springschool.de)

### March 12-15, 2012

Annual Meeting of the German Crystallographic  
Society  
(Munich, Germany)  
[www.dgk-conference.de](http://www.dgk-conference.de)  
Please note the workshop "Neutron Scattering  
for Crystallographers" on March 15-16, 2012 with  
lectures by scientists of the FRM II.  
[www.frm2.tum.de/aktuelles/veranstaltungen/  
archive/dgk-workshop-2011](http://www.frm2.tum.de/aktuelles/veranstaltungen/archive/dgk-workshop-2011)

### March 23, 2012

4<sup>th</sup> User Meeting at the FRM II  
(Garching, Germany)  
[www.frm2.tum.de/user-meeting-2012](http://www.frm2.tum.de/user-meeting-2012)

### March 25-30, 2012

76<sup>th</sup> Annual Meeting of the DPG and DPG Spring  
Meeting  
(Berlin, Germany)  
[berlin12.dpg-tagungen.de](http://berlin12.dpg-tagungen.de)

### April 17, 2012

VDI Experts' Meeting  
(Garching, Germany)  
[www.frm2.tum.de/aktuelles/veranstaltungen/  
vdi-expertenforum-2012](http://www.frm2.tum.de/aktuelles/veranstaltungen/vdi-expertenforum-2012)

### April, 19-20, 2012

Science & Scientists @ ESS  
(Berlin, Germany)  
[esss.se/ess\\_conferences/?page\\_id=54](http://esss.se/ess_conferences/?page_id=54)

### September 3-14, 2012

16<sup>th</sup> JCNS Laboratory Course - Neutron Scatter-  
ing  
(Jülich/ Garching, Germany)  
[www.neutronlab.de](http://www.neutronlab.de)

### September 24-26, 2012

German Conference on Neutron Scattering  
(Bonn, Germany)  
[www.fz-juelich.de/SharedDocs/Termine/  
JCNS/DE/Neutronenstreutagung2012.html](http://www.fz-juelich.de/SharedDocs/Termine/JCNS/DE/Neutronenstreutagung2012.html)

## IMPRINT

### Editors

Flavio Carsughi  
Connie Hesse  
Ina Lommatzsch  
Jürgen Neuhaus  
Andrea Voit

### Picture Credits

H. Frielinghaus, JCNS (9, Fig. 2), A. Heddergott, TUM (35), W. Schürmann, TUM (12-13;  
17, bottom; 23, bottom; 28-30).  
If not indicated: by authors, editors and/ or FRM II.

### Contact

Technische Universität München  
Forschungs-Neutronenquelle Heinz Maier-Leibnitz (FRM II)  
User Office  
Lichtenbergstraße 1  
D-85747 Garching  
Phone: +49.(0)89.289.10794 / 10703  
Fax: +49.(0)89.289.10799  
e-mail: [userinfo@frm2.tum.de](mailto:userinfo@frm2.tum.de)  
[www.frm2.tum.de](http://www.frm2.tum.de)

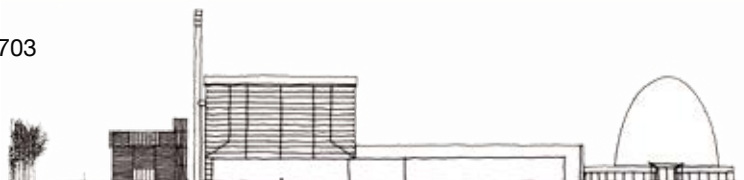



# I WANT TO BELIEVE

The new meteo tower of the Technische Universität München.

**An Unidentified Fishing Object  
similar to a kind of submarine  
conquers the Alps.  
Goal unknown -  
either looking for sustainable  
energy or just interested in soccer?**







news 7 (2011)

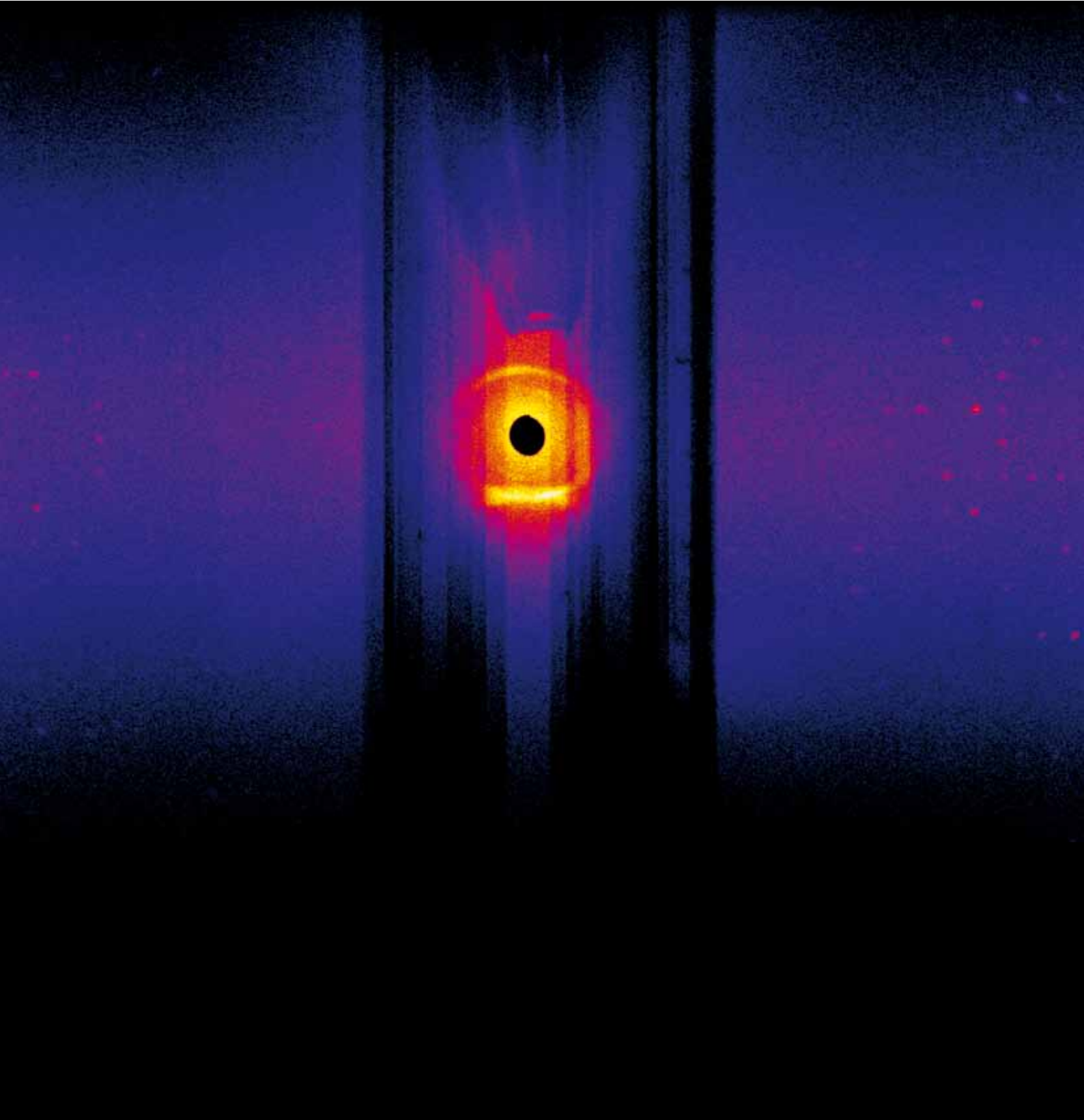

SPONSORED BY THE



Federal Ministry  
of Education  
and Research

funded by

Bayerisches Staatsministerium für  
Wissenschaft, Forschung und Kunst

